KATALOG REZERVNIH DELOVA ZA KOMERCIJALNA VOZILA



SCANIA
2015



ISO 9001:2008
VÁLTI UNIK
04.09.2016.
www.scania.com
0 900 011

KATALOG REZERVNIH DELOVA ZA KOMERCIJALNA VOZILA



www.rapidex.co.rs

SCANIA

2015





NOVI SAD

Novosadski put 160
21000 Novi Sad
Srbija

Tel./Fax.

021 651 0521
021 651 0522
021 651 0523
021 651 1228
021 651 2254
060 824 8801

e-mail: office@rapidex.co.rs



BEOGRAD

Milošev kladenac BB

Tel./Fax.

011 406 59 48
011 406 67 82
011 406 67 83
060 824 8804





PARAĆIN

Carice Milice 54

Tel./Fax.
035 8 567 611
035 8 567 671
060 824 8833



ČAČAK

Konjevići bb

Tel./Fax.
032 559 0037
060 824 8821





LOZNICA

Bulevar Dositeja Obradovića 70

Tel.
015 877 883
015 877 884
060 824 8810



VRBAS

Ivana Milutinovića 11

Tel.
021 700 087
060 824 8806



NOVI PAZAR

Save Kovačevića 300

Tel.
020 315 156,
060 824 8824



NIŠ

Bulevar 12. Februar 152

Tel./Fax.
018 585 824
060 824 8874



VRANJE

Ivana Meštrovića 27

Tel.
017 410 088
060 824 8835



BIJELJINA

RAPIDEX DOO

Pantelinska 1

Tel./Fax.
+387 55 247 687



SOMBOR

XII Vojvodanske udarne brigade 130

Tel.
025 461 481
060 824 8850



LAKTAŠI

RAPIDO DOO

Cara Dušana 218

Tel.
+387 51 584 544



SUBOTICA

Beogradski put 21

Tel.
024 556 246
060 824 8862

WABCO



NARVA





SADRŽAJ:

1.0 MOTOR

1.1	Delovi motora	18
1.2	Pumpe vode i upravljača	21
1.3	Termostati	22
1.4	Španeri motora i prenosni kaiševi	23
1.5	Turbo kompresori	25
1.6	Hlađenje motora (Visko ventilatori, hladnjaci, interkuleri i ekspanzione posude).....	26
1.7	Hlađenje i grejanje kabine (Hladnjaci klime, kompresori klime i izmenjivači toplote).....	28
1.8	Creva vode i interkulera	29
1.9	Filteri	31
1.10	Napajanje gorivom	34
1.11	Davači i senzori	36
1.12	Izduvni sistemi	37

2.0 KVAČILO I TRANSMISIJA

2.1	Setovi kvačila i elementi	42
2.2	Centralni ležajevi kardana	45

3.0 KOČIONA PNEUMATIKA I HIDRAULIKA

3.1	Kompresori i delovi	48
3.2	Isušivači vazduha i filteri	49
3.3	Ventili kočionog sistema	51
3.4	Ventili ogibljenja	55
3.5	Cilindri tristop i membranski	56
3.6	Ventili ABS, EBS i ECAS	58
3.7	Elektronika ECAS	60
3.8	Senzori	61
3.9	Cilindri kvačila	63
3.10	Pribor kočionog sistema	64
3.11	WABCO i WABCOWÜRTH dijagnostika	73

4.0 KOMPONENTE KOČIONOG SISTEMA

4.1	Disk kočnica	82
4.2	Kočione pločice	83
4.3	Čeljusti kočnica	84
4.4	Doboši kočnica	85
4.5	Kočione obloge	86
4.6	Šteleri kočnica	87
4.7	Glavčine točka, ležajevi i semerinzi	88
4.8	Vijci i navrtke	91

5.0 ELEMENTI OGIBLJENJA I UPRAVLJANJA

5.1	Amortizeri	94
5.2	Vazdušni jastuci	97
5.3	Gibnjevi	100
5.4	Delovi stabilizatora	103
5.5	Delovi rukavca	104
5.6	Spone i delovi spona	105
5.7	Uporne spone	108
5.8	V spone	109

6.0 KABINA I DELOVI KABINE

6.1	Delovi kabine	112
6.2	Ogledala i delovi ogledala	129
6.3	Cilindri i pumpe za dizanje kabine	130
6.4	Elementi za oslanjanje kabine	131
6.5	Uređaji za pranje vetrobranskog stakla	134
6.6	Mehanizam vrata	135

7.0 ELEKTRIČNE INSTALACIJE

7.1	Farovi	138
7.2	Pokazivači pravca	142
7.3	Stop i gabaritna svetla	143
7.4	Rotacione lampe	147
7.5	Sijalice, osigurači i tahograf listići	150
7.6	Kablovi električne instalacije	155
7.7	Kombinovani prekidači pod volanom	158
7.8	Pribori	159
7.9	Anlaseri i alternatori	160

8.0 PRIBORI

8.1	Obeležavajuće table i pribori A.D.R.	164
8.2	Oprema	179
8.3	Pribor za osiguravanje tereta	182
8.4	Lanci za sneg	184
8.5	Vučne kuke	186
8.6	Grejanje kabine	189

9.0 ULJA I MAZIVA

9.1	Ulja i maziva	195
-----	---------------------	-----

1.0 MOTOR

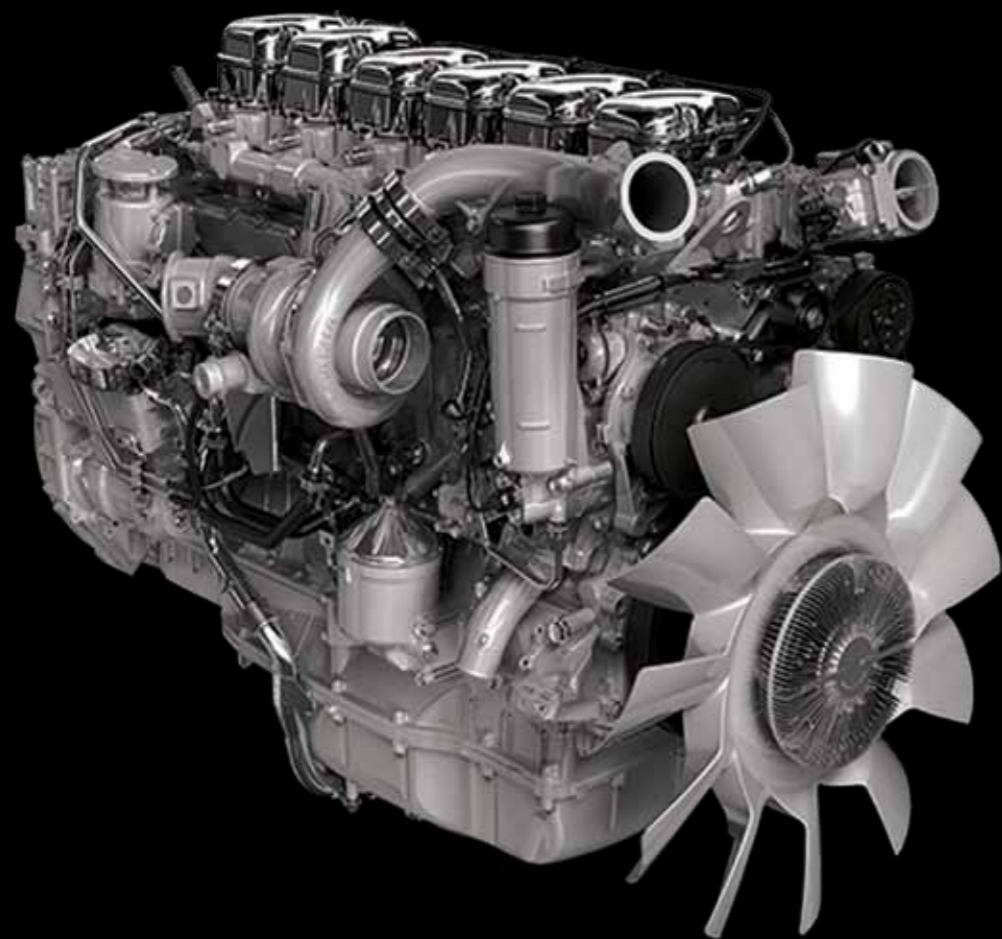

1.0 MOTOR

1.1	Delovi motora	18
1.2	Pumpe vode i upravljača	21
1.3	Termostati	22
1.4	Španeri motora i prenosni kaiševi	23
1.5	Turbo kompresori	25
1.6	Hlađenje motora (Visko ventilatori, hladnjaci, interkuleri i ekspanzione posude)	26
1.7	Hlađenje i grejanje kabine (Hladnjaci klime, kompresori klime i izmenjivači toplote)	28
1.8	Creva vode i interkulera	29
1.9	Filteri	31
1.10	Napajanje gorivom	34
1.11	Davači i senzori	36
1.12	Izduvni sistemi	37







DELOVI MOTORA								
Poz.	Naziv	Federal Mogul broj	Mahle broj	KS broj	Dimenzije (mm)	Tip motora	OE broj	RAPIDEX broj
1.	Klip KPL	87-123200-10	038 56 00	40 338 600	131	D12C, D12D EU III	20431540	MOTO2207
2.	Klip KPL	87-123200-00	038 08 00	40 100 600	131	D12D EU III	20364470	MOTO2206
3.	Klip KPL	87-142000-00	038 57 90	40 276 960	120	D9A EU III	85103701	MOTO2208
4.	Klip KPL	87-141900-00	038 62 00	40 308 600	107	D7C EU II	276908	MOTO2066
5.	Košuljica	14-450590-00	037 WN 48	89 593 110	131	D12C, D12D EU III	20498544	MOTO0775
6.	Košuljica	15-450160-00	037 WN 35	89 460 110	131	D12D EU III	1677874	MOTO2209
7.	Košuljica	14-480230-00	037 WN 50	89 826 110	120	D9A EU III	20381125	MOTO2210

DELOVI MOTORA								
Poz.	Naziv	Federal Mogul broj	Mahle broj	KS broj	Dimenzije (mm)	Tip motora	OE broj	RAPIDEX broj
8.	Košuljica	14-450810-00	037 WN 52	89 839 110	107	D7C EU II	20483013	MOTO2065
9.	Karika	08-141900-00	038 62 N0	800070610	107	D7C EU II	276905	MOTO2211
10.	Karika	08-142000-00	038 57 N0	800058610	120	D9A EU III	20463853	MOTO2212
11.	Karika	08-123200-00	038 43 N0	800044410	131	D12C, D12D EU III	20509932	MOTO0764
12.	Ležajevi radilice - leteći	71-3964/6	038 PS 20732	77 843 600	73,8 x 77,7 x 37,1	D7C EU II	276909	MOTO2017
13.	Ležajevi radilice - leteći	71-4023/6	038 PS 20095	77 833 600	88 x 92,8 x 45,10	D9A EU III	307783905	MOTO2016
14.	Ležajevi radilice - leteći	71-3923/6	038 PL 19914	77 750 600	92 x 96,8 x 49,10	D12C, D12D EU III	276134	MOTO0765
15.	Ležajevi radilice - ležeći	H1303/7	038 HS 20091	77 842 600	90,5 x 96,5 x 30,4	D7C EU II	276894	MOTO2112
16.	Ležajevi radilice - ležeći	H1008/7	038 HS 20097	72 732 600	118 x 113 x 32,20	D9A EU III	8148115	MOTO2111
17.	Ležajevi radilice - ležeći	H1015/7	038 HL 19913	77 751 600	108 x 113 x 37,80	D12C, D12D EU III	2053090103	MOTO2213
18.	Aksijalni ležaj radilice	A131/4	037 AS 10668	78 520 600	117 x 139 x 3,213	D12C, D12D EU III	276791	MOTO1938
19.	Čaura klipnjače	55-3965	-	77 871 690	47 x 52 x 36,6	D7C EU II	8192806	MOTO2214
20.	Čaura klipnjače	55-4025	-	-	54 x 59 x 40,25	D9A EU III	20583429	MOTO2215
21.	Čaura klipnjače	55-3925	038 BB 18088	72 446 690	55 x 60,3 x 46,75	D12C, D12D EU III	470434	MOTO2216

1

DELOVI MOTORA								
Poz.	Naziv	Federal Mogul broj	Reinz broj	Elring broj	Dimenzije (mm)	Tip motora	OE broj	RAPIDEX broj
22.	Garnitura zaptivača	-	01-29095-01	138.140	131	D12A	276888	MOTO2217
23.	Garnitura zaptivača	-	01-36260-01	390.300	131	D12C, D12D EU III	20710309	MOTO1367
24.	Set zaptivača glave	-	02-36435-01	395.500	120	D9A EU III	20515369	MOTO2218
25.	Set zaptivača glave	-	02-36260-01	390.210	131	D12C, D12D EU III	20710242	MOTO2219
26.	Set zaptivača glave	-	02-29095-01	390.100	131	D12C, D12D EU III	276875	MOTO2220
27.	Zaptivač glave	-	61-31095-10	750.530	107	D7C EU II	276816	MOTO2046
28.	Zaptivač glave	-	61-36435-00	225.100	120	D9A EU III	8148046	MOTO2221
29.	Zaptivač glave	-	61-29095-10	005.100	131	D9A EU III	3093503	MOTO1496
30.	Zaptivač glave	-	61-36260-10	115.151	131	D12C, D12D EU III	3099100	MOTO1356
31.	Semering radilice	-	81-31168-00	754.669	76,2 x 101,68 x 12	D7C EU II	477118	MOTO2048
32.	Semering radilice	-	81-26294-10	518.361	127 x 150 x 13	D7C EU II	477119	MOTO2047
33.	Semering radilice	-	81-38651-00	000.270	136 x 159 x 13	D9A EU III	21347087	MOTO2222
34.	Semering radilice	-	81-35206-10	081.460	180 x 205 x 15	D9A EU III, D12C, D12D EU III	85108352	MOTO1358
35.	Semering radilice	-	81-38651-10	000.270	136 x 159 x 13	D12C, D12D EU III	1549398	MOTO2222

1

PUMPE VODE						
Slika	Poz.	Model vozila	Tip motora	Frimatec broj	OE broj	RAPIDEX broj
	1.	92, 93	DN9, DS9, DSC9	220834	1377571	MOTO0284
	2.	94	DSC9	2201079	1380897	MOTO0275
	3.	114, 124	DSC11, DSC12	220941	1372365	MOTO0105
	4.	144	DSC14	220940	1365841	MOTO0010
	5.	SERIJA 4, P, G, R, T	D9, D11, D12, DC9, DC19, DC21	2201102	1570959	MOTO1275

PUMPE UPRAVLJAČA				
Slika	Poz.	Model vozila	OE broj	RAPIDEX broj
	1.	SERIJA 2	571364	HIDR0014

TERMOSTATI						
Slika	Poz.	Model vozila	T [°C]	KBP	OE broj	RAPIDEX broj
	1.	114, 124, 144, 164	79°C	TH7103.79J	283281	MOTO2172
	2.	114, 124, 144, 164, P, G, R, T	80°C	TH7105.83J	1358995	MOTO1919
	3.	114, 124, 144, 164, P, G, R, T	83°C	TH7117.80J	1404925	MOTO1684
	4.	114, 124, 144, 164, P, G, R, T	83°C	TH7106.83J	1404924	MOTO1698



ŠPANERI					
Poz.	Slika	Model vozila	OE broj	KBP	RAPIDEX broj
1.		114, 124, 144, 164	1859655	VKM CV56004	MOTO0798
2.		114, 124, 144, 164	1859654	VKM CV56001	MOTO0315
3.		164, R500, R580	1438743	VKM CV56005	MOTO2388
4.		P, G, R, T	1859657	APV1120	MOTO1547
5.		P, G, R, T	1870552	APV2732	MOTO2878

ROLERI				
Poz.	Model vozila	OE broj	KBP	RAPIDEX broj
1.	114, 124, 144, 164	1514086	VKM CV56002	MOTO0314
2.	114, 124, 144, 164	1413609	VKM CV56003	MOTO0152
3.	P, G, R, T	1858885	APV1121	MOTO1490
4.	P, G, R, T	1858884	APV1119	MOTO2071
5.	P, G, R, T	1860734	APV2730	MOTO2799
6.	P, G, R, T	1870551	APV2733	MOTO2978

KLINASTI I PK KAIŠEVI

Poz.	Dimenzija (mm)	Model vozila	RAPIDEX broj
1.	13 x 1200	DSC14, DC11	REME0218
2.	13 x 1300	DSC14	VESA0541
3.	13 x 1375	BUS	REME0092
4.	13 x 1575	113, 114	REME0222
5.	13 x 1600	113, 114	REME0223
6.	13 x 1625	113, 114	REME0096
7.	13 x 1750	113, 124	REME0224
8.	8PK 1255	124, 164	REME0118
9.	8PK 1510	124, 164	REME0127
10.	8PK 1550	114, 124, 164	REME0226
11.	8PK 1585	114, 124, 164	REME0132
12.	8PK 1988	114, 124, 144	REME0151
13.	8PK 2045	114, 124, 164	REME0155
14.	8PK 2080	114, 124, 164	REME0227
15.	8PK 2130	P, G, R, T	REME0352
16.	8PK 2220	124, 144	REME0158
17.	10PK 2020	P, G, R, T	REME0603
18.	10PK 2220	P, G, R, T	REME0604

TURBO KOMPRESORI

Poz.	Model vozila	OE broj	RAPIDEX broj
1.	DSC9, DCS12	1501641	MOTO0961
2.	DSC11	1423029	MOTO0962
3.	DSC12	1375883	MOTO0963
4.	DSC14	1384862	MOTO0964

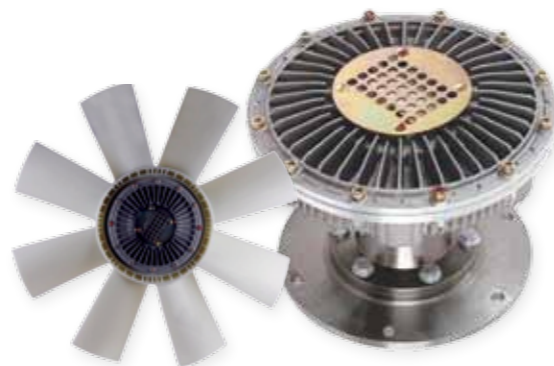
VISKO VENTILATORI

Poz.	Model vozila	Dimenzija (mm)	OE broj	RAPIDEX broj
1.	SERIJA 3	Ø199	1480770	MOTO1243
2.	114, 124	Ø750 8p	1393424	MOTO0944
3.	114, 124	Ø680 8p	1402869	MOTO0945
4.	SERIJA 4	Ø203,2	1349551	MOTO1244
5.	SERIJA P, G, R, T	-	1402859	MOTO1607
6.	SERIJA P, G, R, T	Ø750 8p	1453967	MOTO2401

HLADNJACI

Poz.	Model vozila	Dimenzija (mm)	OE broj	RAPIDEX broj
1.	SERIJA 4	860 x 964 x 40	1327249	HLAĐ0028
2.	SERIJA P, G, R, T	860 x 990 x 40	1527653	HLAĐ0641

INTERKULERI

Poz.	Model vozila	Dimenzija (mm)	OE broj	RAPIDEX broj
1.	SERIJA 4	825 x 794 x 63	1408882	HLAĐ0507
2.	SERIJA P, G, R, T	828 x 792 x 66	1547316	HLAĐ0324

EKSPANZIONE POSUDE

Poz.	Model vozila	Dimenzija (mm)	OE broj	RAPIDEX broj
1.	SERIJA 4	444 x 233 x 279 10,5 l	1370707	HLAĐ0410
2.	SERIJA P, G, R, T	-	1949013	HLAĐ0931



HLADNJACI KLIME				
Poz.	Model vozila	Dimenzija (mm)	OE broj	RAPIDEX broj
1.	SERIJA 4	820 x 460 x 24	1449757	HLAĐ0532
2.	SERIJA P, G, R, T	706 x 373 x 17	1446258	HLAĐ0817



KOMPRESORI KLIME				
Poz.	Model vozila	Opis	OE broj	RAPIDEX broj
1.	SERIJA 4 P, G, R, T	Remenica Ø119 mm, 8 kanala	1376998	MOTO2857



IZMENJIVAČI TOPLOTE				
Poz.	Model vozila	Dimenzija (mm)	OE broj	RAPIDEX broj
1.	SERIJA 4	453 x 157 x 32	1437263	HLAĐ0264

CREVA VODE					
Slika	Poz.	Model vozila	Dimenzije (mm)	OE broj	RAPIDEX broj
	1.	124, 164	31 x 34 x 310	1426194	HLAĐ0093
	2.	114, 124, 164	10 x 10 x 540	1376895	HLAĐ0236
	3.	114, 124, 164	10 x 10 x 685	1376896	HLAĐ0237
	4.	114, 124, 164	55 x 55 x 580	1449431	HLAĐ0091
	5.	114, 124, 164	54 x 54 x 640	1529007	HLAĐ0101
	6.	114, 124, 164	56 x 56 x 440	1377231	HLAĐ0092
	7.	114, 124, 164	55 x 55 x 410	1385086	HLAĐ0238
	8.	114, 124, 164	55 x 55 x 420	1395066	HLAĐ0239
	9.	114, 124, 164	55 x 55 x 510	1511620	HLAĐ0686
	10.	114, 124, 164	56 x 465	1422499	HLAĐ0687

CREVA VODE					
Slika	Poz.	Model vozila	Dimenzije (mm)	OE broj	RAPIDEX broj
	11.	114, 124, 164	30 x 360 x 850	1545116	HLAĐ0688
	12.	P, G, R, T	56 x 475	1517770	HLAĐ0689
	13.	P, G, R, T	55 x 55 x 670	1755951	HLAĐ0690
	14.	P, G, R, T	56 x 56 x 630	1496815	HLAĐ0691
	15.	P, G, R, T	25 x 31 x 75	1755954	HLAĐ0692

CREVA INTERKULERA					
Slika	Poz.	Model vozila	Dimenzije (mm)	OE broj	RAPIDEX broj
	1.	94, 114, 124, 144, 164	Ø90 x 140	488368	HLAĐ0349
	2.	94, 114, 124, 144, 164 P, G, R, T	Ø100 x 182	1794725	HLAĐ0348
	3.	94, 114, 124, 144, 164 P, G, R, T	Ø80 x 182	1525145	HLAĐ0693

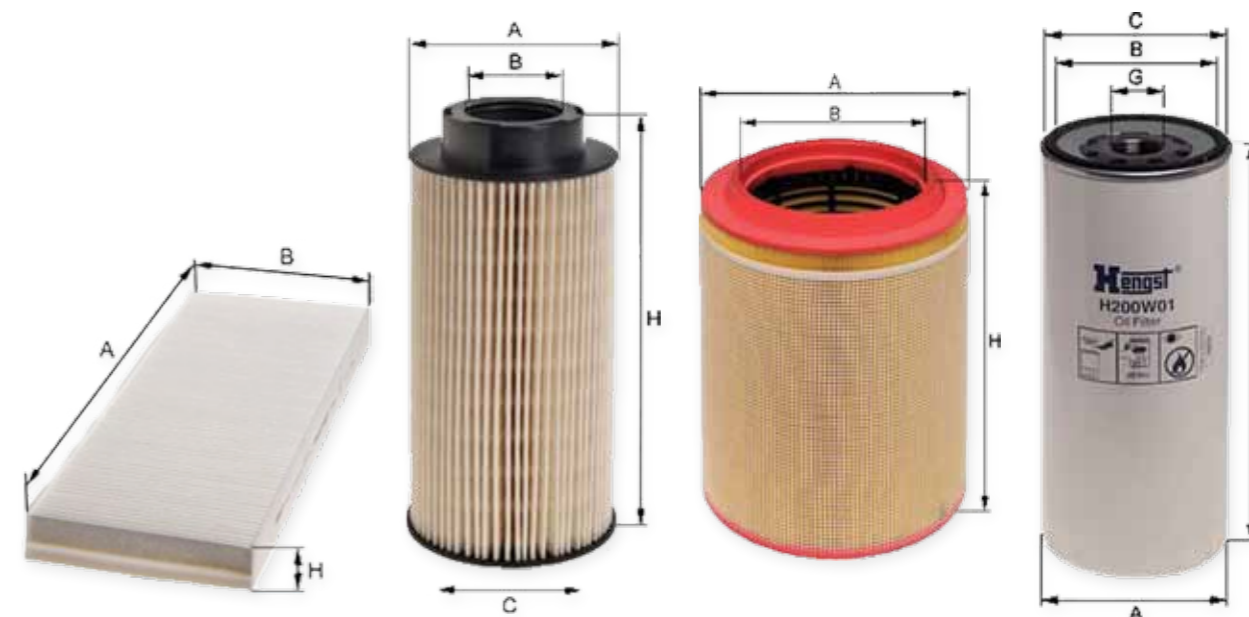

FILTERI ULJA									
Poz.	Hengst broj	A (mm)	B (mm)	C (mm)	G (mm)	H (mm)	Model vozila	OE broj	RAPIDEX broj
1.	H200W02 H200W20	110,00	93,00	104,00	1 1/8-16 UNS	260,00	SERIJA 4 94, 114, 124, 144 1995-2004, SERIJA G, P, R, T 230-480 2004-	1117285	FILT0256
2.	E21HD74	102,20	44,80	-	-	252,00	SERIJA 4 164 1995-2004, SERIJA G, P, R, T 500-730 2004-	1439036	FILT0299
3.	E123HD194	90,00	45,50	46,00	-	281,00	SERIJA G, P, R, T 230-480 2007-	1742032	FILT0793

FILTERI GORIVA									
Poz.	Hengst broj	A (mm)	B (mm)	C (mm)	G (mm)	H (mm)	Model vozila	OE broj	RAPIDEX broj
1.	H60WK08	76,00	62,00	71,00	M16 x 1,5	126,50	SERIJA 2, 3	1401462	FILT0006
2.	H17WK04	93,00	62,00	72,00	M24 x 1,5	141,00	SERIJA 4 94, 114, 124, 144 1995-2004 SERIJA G, P, R, T 230-480 2004-	1373082	FILT0261
3.	H17WK11	93,50	62,50	71,50	M24 x 1,5	142,00	SERIJA 4 94, 114, 124, 144 1995-2004 SERIJA G, P, R, T 230-480 2004-	1411894	FILT0166
4.	E68KP01D73	83,00	38,00	85,00	-	185,00	SERIJA 4 124 1995-2004 SERIJA G, P, R, T 230-480 2004-	1459672	FILT0991
5.	E57KPD73	85,00	38,00	-	-	180,50	SERIJA 4 164 1995-2004 SERIJA G, P, R, T 420-620 2004-	1429059	FILT0313
6.	E103KPD197 SET (2 kom)	95,00	45,00	-	-	203,00	SERIJA G, P, R, T 230-480 2007-	1736248	FILT0792
		85,00	38,00	-	-	222,50			

SEPARATOR GORIVA									
Poz.	Hengst broj	A (mm)	B (mm)	C (mm)	G (mm)	H (mm)	Model vozila	OE broj	RAPIDEX broj
1.	H7090WK30	108,00	-	91,00	1-14 UNS	157,00	SERIJA 4 1995-2004 SERIJA G, P, R, T 2004-	1393640	FILT0210
2.	H704WK	111,50	80,00	91,00	1-14 UNS	182,00	SERIJA 4 1995-2004 SERIJA G, P, R, T 2004-	1518512	FILT1118



FILTERI VAZDUHA									
Poz.	Hengst broj	A (mm)	B (mm)	C (mm)	G (mm)	H (mm)	Model vozila	OE broj	RAPIDEX broj
1.	E218L	302,00	191,00	-	-	381,00	SERIJA 2, 3	371307	FILT0058
2.	E1013L	303,00	167,00	-	-	446,00	SERIJA 4 94, 114, 124, 144 1995-2004 SERIJA G, P, R, T 230-480 2004-	1335679	FILT0738
3.	E424L	309,50	177,00	-	-	464,00	SERIJA 4 94, 114, 124, 144 1995-2004 SERIJA G, P, R, T 230-480 2004-	1387549	FILT0283
4.	E1016L	267,00	159,00	-	-	535,00	SERIJA G, P, R, T 230-480 2004-	1485592	FILT0920
5.	E1033L	303,00	167,00	-	-	526,00	SERIJA 4 144, 164 1995-2004 SERIJA G, P, R, T 500-730 2004-	1335678	FILT0886
6.	E540L	304,00	178,00	-	-	543,00	SERIJA 4 144, 164 1995-2004 SERIJA G, P, R, T 500-620 2004-	1387548	FILT0315

FILTERI KABINE									
Poz.	Hengst broj	A (mm)	B (mm)	C (mm)	G (mm)	H (mm)	Model vozila	OE broj	RAPIDEX broj
1.	E956LI01	223,00	165,00	-	-	69,00	SERIJA 4, 1995-2004 SERIJA G, P, R, T 2004-	1379952	FILT0265
2.	E2960LI	366,50	128,00	-	-	20,00	SERIJA G, P, R, T 2004-	1770813	FILT0460

OSTALI FILTERI									
Poz.	Hengst broj	A (mm)	B (mm)	C (mm)	G (mm)	H (mm)	Model vozila	OE broj	RAPIDEX broj
1.	E10H02	58,00	18,50	18,50	-	100,00	SVI MODELI Filter hidraulike volana	1953094	FILT0214
2.	E41H	84,00	19,50	-	-	107,00	SERIJA 3, 4 1988-2004	1329876	FILT0287
3.	H24W05 Menjač, Diferencijal	94,00	63,00	72,00	M23 x 1,5	116,00	SERIJA 3, 4 1988-2004 SERIJA G, P, R, T 2004-	1301696	FILT0249
4.	E101UD178 Ad blue	69,00	25,00	-	-	75,00	SERIJA G, P, R, T 2004-	1545482	FILT0015

BRIZGALJKE I ULOŠCI BRIZGALJKI

Poz.	Model vozila / Tip motora	KBP	OE broj	RAPIDEX broj
1.	SERIJA 4, Truck, Bus	DLLA150P847	1409192	NAP.0131
2.	SERIJA 4, Truck, Bus	DLLA150P848	1412401	NAP.0132
3.	SERIJA 4, DC11, 12, 16	DLLA150P898	1438333	NAP.0133
4.	SERIJA 4, DC11, 12, 16	DLLA150P635	1380777	NAP.0134
5.	SERIJA 3, 4, Truck, Bus	DLLA155P306	1327377	NAP.0135
6.	SERIJA 4, Truck, Bus	DLLA150P573	1375440	NAP.0136
7.	SERIJA 4, Truck, Bus	DLLA147P538	1364500	NAP.0137

AC PUMPE

Poz.	Model vozila	OE broj	RAPIDEX broj
1.	DSC9, DC9	1375493	NAP.0178
2.	DC11, DSC11, DSC12	1307770	NAP.0179
3.	DC9, DC11, D12	1539298	NAP.0180
4.	DC16	1536255	NAP.0181

REZERVOARI GORIVA



Poz.	Model vozila	Dimenzija (mm)	Zapremina (l)	RAPIDEX broj
1.	SERIJA 4	1460 x 720 x 720	700	NAP.0196
2.	SERIJA 4	1960 x 720 x 720	930	NAP.0197



POKLOPCI

Poz.	Naziv	Model vozila	OE broj	RAPIDEX broj
1.	POKLOPAC REZERVOARA Ø60 mm	SERIJA 4, 94, 114, 124, 144, 164	1481301	OPRE0469
2.	POKLOPAC ULJA	DSC, DC9, 11, DSC14	1385367	OPRE0470
3.	POKLOPAC EKSPANZIONE POSUDE	SERIJA 4, 94, 114, 124, 144, 164	1374050	OPRE0471

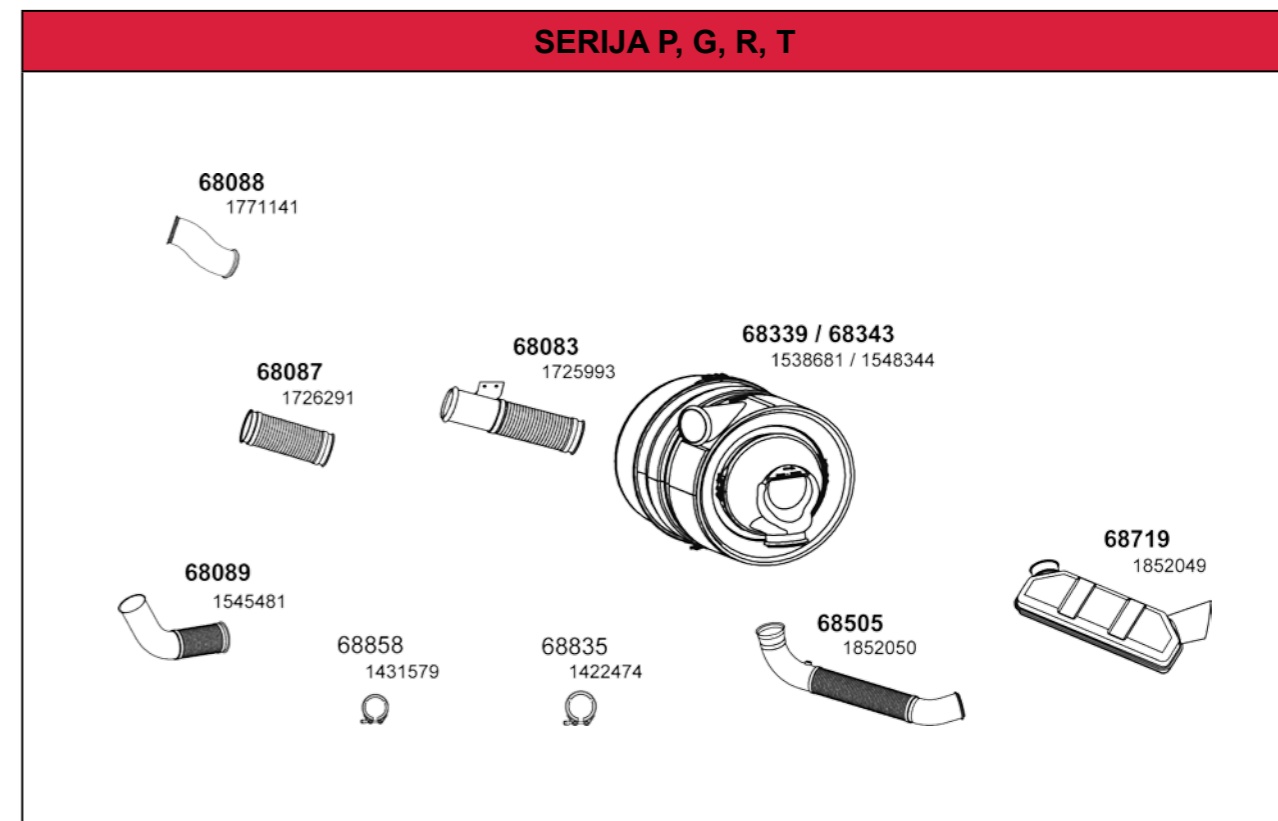

PLOVCI

Poz.	Model vozila	OE broj	RAPIDEX broj
1.	94, 114, 124, 144, 164	1423990	NAP.0209
2.	94, 114, 124, 144, 164	1424074	NAP.0210

DAVAČI I SENZORI						
Slika	Poz.	Model vozila	Tip motora	Dimenzije (mm)	OE broj	RAPIDEX broj
	1.	SERIJA 2, 3, 4	DSC9, DC9, DSC12, DC12	0-10 bar, 0,7±0,15, M14 x 1,5	374338	MOTO0846
	2.	SERIJA 2, 3, 4	DSC11, DSC14	M14 x 1,5	1316331	MOTO0847
	3.	SERIJA 4,	DSC9, DC9, DSC12, DC12, DSC14		1452862	MOTO0848

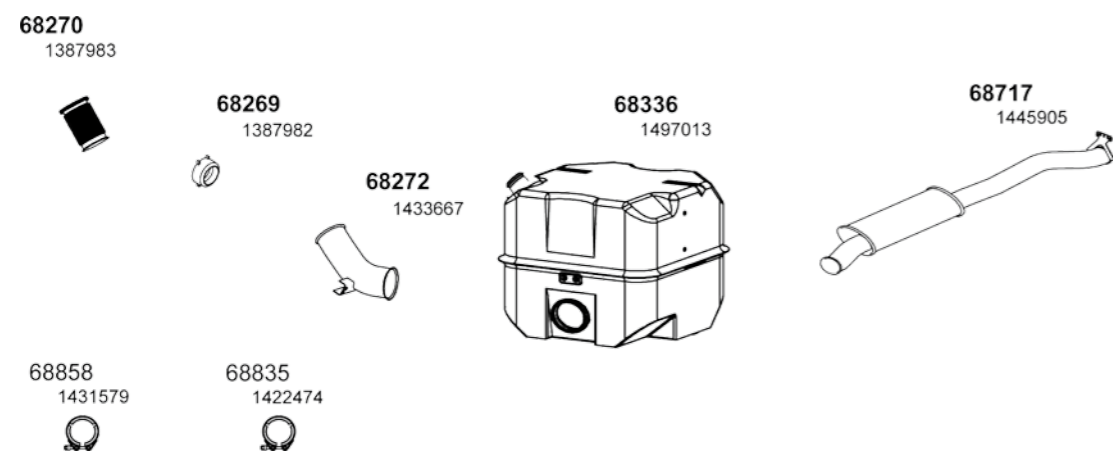

ELEMENTI IZDUVNOG SISTEMA - SERIJA P, G, R, T				
Poz.	Naziv	Dinex broj	OE broj	RAPIDEX broj
1.	LONAC	68339	1538681	IZDU0515
2.	LONAC	68343	1548344	IZDU0516
3.	LONAC IZDUVNI MALI	68719	1852049	IZDU0517
4.	CEV	68505	1852050	IZDU0378
5.	CEV	68083	1725993	IZDU0518
6.	CEV GIBLJIVA	68087	1726291	IZDU0519
7.	CEV	68088	1771141	IZDU0520
8.	CEV	68089	1545481	IZDU0521
9.	ŠELNA	68835	1422474	IZDU0337
10.	ŠELNA	68858	1431579	IZDU0522

SERIJA 4 R164

ELEMENTI IZDUVNOG SISTEMA - SERIJA 4 R164

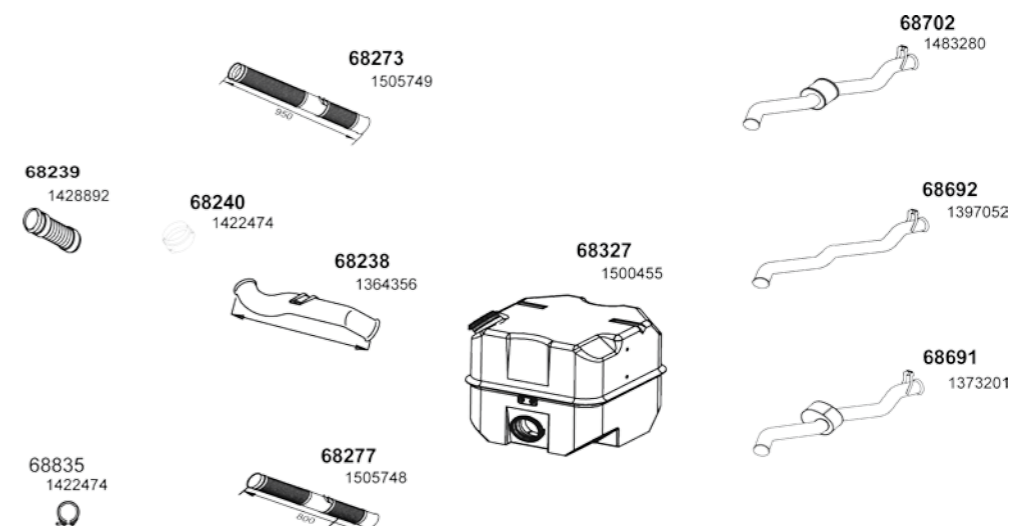
Poz.	Naziv	Dinex broj	OE broj	RAPIDEX broj
1.	LONAC	68336	1497013	IZDU0250
2.	CEV SA LONCEM IZDUVNA	68717	1445905	IZDU0523
3.	CEV	68272	1433667	IZDU0524
4.	KLIZAČ	58269	1387982	IZDU0525
5.	CEV GIBLJIVA	68270	1387983	IZDU0437
6.	ŠELNA	68858	1431579	IZDU0522
7.	ŠELNA	68835	1422474	IZDU0337

SERIJA 4

ELEMENTI IZDUVNOG SISTEMA - SERIJA 4

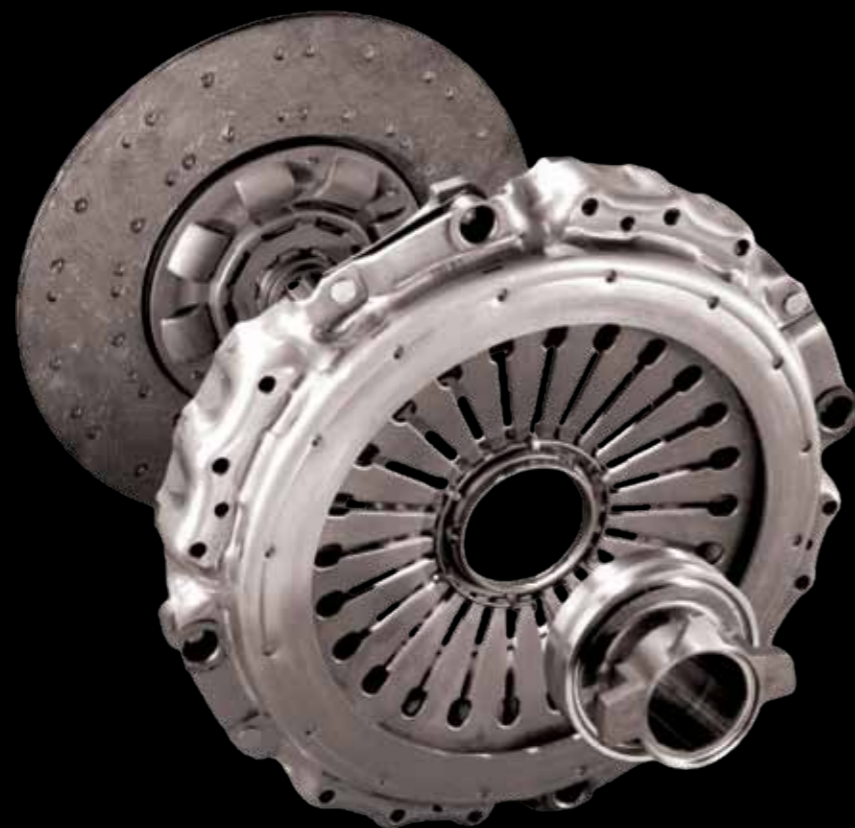
Poz.	Naziv	Dinex broj	OE broj	RAPIDEX broj
1.	LONAC	68327	1500455	IZDU0427
2.	CEV SA LONCEM IZDUVNA	68702	1483280	IZDU0148
3.	CEV IZDUVNA	68692	1397052	IZDU0147
4.	CEV SA LONCEM IZDUVNA	68691	1373201	IZDU0526
5.	CEV	68273	1505749	IZDU0527
6.	CEV	68277	1505748	IZDU0375
7.	CEV	68238	1364356	IZDU0150
8.	KLIZAČ	68240	1364290	IZDU0528
9.	CEV GIBLJIVA	68239	1364355	IZDU0153
10.	ŠELNA	68835	1422474	IZDU0337

2.0 KVAČILO I TRANSMISIJA



2.0 KVAČILO I TRANSMISIJA

- 2.1 Setovi kvačila i elementi 42
- 2.2 Centralni ležajevi kardana 45

SETOVI KVAČILA

Poz.	Model vozila	Prečnik	Broj zuba	KBP	OE broj	RAPIDEX broj
1.	114, 124, 164	Ø430 mm	24	3400 700 356	1749125	MENJ0465
2.	114, 124, 144, 164	Ø430 mm	24	3400 122 001 (bez druk ležaja)	1321258	MENJ0205
3.	114, 124, 144, 164	Ø430 mm	24	3400 710 004	1322584	MENJ0470
4.	114, 124, 144, 164 P, G, R	Ø430 mm	24	3400 700 352	572943	MENJ0199
5.	P, G, R, T	Ø430 mm	24	3400 700 371	572950	MENJ0574
6.	P, G, R, T	Ø430 mm	24	3400 700 372	572943	MENJ0553
7.	P, G, R, T	Ø430 mm	24	827293	-	MENJ0482

POTISNI LEŽAJEVI

Poz.	Slika	Model vozila	KBP	OE broj	RAPIDEX broj
1.		113, 143,	T7000.23	1393163	MENJ0212
2.		113, 143,	T7000.34	1407430	MENJ0209
3.		114, 124, 144, 164	3182 009 938	1522377	MENJ0238
4.		114, 124, 144, 164 P, G, R, T	3151 000 151	1479576	MENJ0063





KORPE KVAČILA

Poz.	Model vozila	Prečnik	Tip	KBP	OE broj	RAPIDEX broj
1.	114, 124, 164	Ø430 mm	MFZ430	3482 083 150	1341687	KVAC0172
2.	114, 124, 144, 164 P, G, R, T	Ø430 mm	MFZ430	3482 000 257	1513718	KVAC0357
3.	P, G, R, T	Ø430 mm	MFZ430	3482 000 556	1547163	KVAC0376
4.	93, 143 114, 124, 144, 164	Ø430 mm	MFZ430	3482 083 039	1370794	MENJ0215



LAMELE KVAČILA

Poz.	Model vozila	Prečnik	Broj zuba	KBP	OE broj	RAPIDEX broj
1.	113,14	Ø420 mm	22	T3003.620	1332108	KVAC0091
2.	142, 113, 143	Ø430 mm	22	T3003.61	1387021	KVAC0112
3.	114, 124, 144, 164	Ø430 mm	24	1878 063 231	1749123	KVAC0017
4.	P, R, G, T	Ø430 mm	24	1878 003 839	1479575	KVAC0358



CENTRALNI LEŽAJEVI KARDANA

Poz.	Slika	Model	Ø (mm)	B (mm)	L (mm)	OE broj	RAPIDEX broj
1.		93, 112, 113, 143	60/82	22	-	294270	MENJ0317
2.		93, 112, 113, 143	60/87	22	-	1113031	MENJ0318



3.0 KOČIONA PNEUMATIKA I HIDRAULIKA





3.0 KOČIONA PNEUMATIKA I HIDRAULIKA

3.1	Kompresori i delovi	48
3.2	Isušivači vazduha i filteri	49
3.3	Ventili kočionog sistema	51
3.4	Ventili ogibljenja	55
3.5	Cilindri tristop i membranski	56
3.6	Ventili ABS, EBS i ECAS	58
3.7	Elektronika ECAS	60
3.8	Senzori	61
3.9	Cilindri kvačila	63
3.10	Pribor kočionog sistema	64
3.11	WABCO i WABCOWÜRTH dijagnostika	73

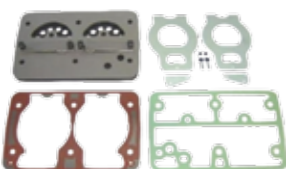
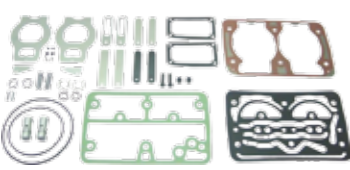
KOMPRESORI					
Poz.	Slika	KBP	Model / Opis	OE broj	RAPIDEX broj
1.		LK4941	P, G, R, T	1796663	KOCN4316

GLAVE KOMPRESORA					
Poz.	Slika	KBP	Model / Opis	Aparat / OE broj	RAPIDEX broj
1.		14 01 60	P, G, R, T	-	KOCN4212
2.		14 01 20	P, G, R, T	1424766	KOCN3238
3.		1400 010 650	P, G, R, T	1376272	KOCN4317
3.		1400 010 500	P, G, R, T	1376281	KOCN2121

ISUŠIVAČI VAZDUHA					
Poz.	Slika	KBP	Model / Opis	OE broj	RAPIDEX broj
1.		432 410 083 0	SERIJA 3 SERIJA 4 9,5 bar	1932678	KOCN2020
2.		78985	SERIJA 4 12,5 bar	1354874	KOCN1937
3.		932 510 956 2	SERIJA P, G, R, T 12,5 bar	1774871	KOCN2272







FILTERI ISUŠIVAČA VAZDUHA					
Poz.	Slika	KBP	Model / Opis	OE broj	RAPIDEX broj
1.		432 410 927 2	SERIJA 4 P, G, R, T G 1 1/4"	1384549	KOCN1030
2.		432 901 228 2	SERIJA 4 P, G, R, T PROTECTOR G 1 1/4"	1774598	FILT0207
3.		T350W	SERIJA 4 PLASTIČNI	1393551	FILT0304

ČETVOROKRUŽNI / ŠESTOKRUŽNI ZAŠTITNI VENTILI						
Poz.	Slika	KBP	Model	Opis	OE broj	RAPIDEX broj
1.		934 714 211 0	SERIJA 4	M22/M16, MAX 13 bar, 7,4 bar	1431049	KOCN1496
2.		932 510 958 2	SERIJA P,G,R,T	VISEKRUŽNI VENTIL ISUSIVACA	2077976	KOCN2334

VENTILI RELEJNI					
Poz.	Slika	KBP	Model	OE broj	RAPIDEX broj
1.		973 011 050 0	SERIJA 4	1342598	KOCN0566

VENTILI BRZOG ISPUSTA

Poz.	Slika	KBP	Model	Opis	OE broj	RAPIDEX broj
1.		973 500 000 0	-	M22 x 1,5 mm	1339907	KOCN1273
2.		973 500 028 0	-	M22 x 1,5 mm 23M16 VOSS	-	KOCN1141
3.		973 500 038 0	-	M 22 x 1,5 mm M16	1738495	KOCN0501
4.		973 500 042 0	-	M 22 x 1,5 mm VOSS	-	KOCN0702
5.		973 500 051 0	-	INTERGISAN DUPLI	1788954	KOCN0997

DVOSMERNI VENTILI

Poz.	Slika	KBP	Model	OE broj	RAPIDEX broj
1.		434 202 000 0	UNIVERZALNI	-	KOCN1280
2.		434 208 000 0	UNIVERZALNI	-	KOCN0590
3.		434 208 029 0	UNIVERZALNI	-	KOCN0888

PRELIVNI VENTILI

Poz.	Slika	KBP	Model	OE broj	RAPIDEX broj
1.		434 100 125 0	UNIVERZALNI	-	KOCN0766
2.		434 100 130 0	UNIVERZALNI	-	KOCN2472
3.		434 100 228 0	UNIVERZALNI	1932747	KOCN2631

VENTIL RAZVODNIK					
Poz.	Slika	KBP	Model	OE broj	RAPIDEX broj
1.		463 036 000 0	UNIVERZALNI	1934917	KOCN1674
2.		463 036 001 0	UNIVERZALNI	1934918	KOCN1086

VENTILI RUČNE PARKIRNE KOČNICE					
Poz.	Slika	KBP	Model	OE broj	RAPIDEX broj
1.		961 722 314 0	SERIJA 3	1518227	KOCN0609

VENTILI UPRAVLJANJA PRIKOLICE					
Poz.	Slika	KBP	Model	OE broj	RAPIDEX broj
1.		973 009 010 0	SERIJA 4 P, G, R, T	1350096	KOCN1682

VENTILI NIVELACIJE VAZDUŠNOG OGIBLJENJA					
Poz.	Slika	KBP	Model	OE broj	RAPIDEX broj
1.		464 006 002 0	SERIJA 3	339792	VESA0773

VENTILI NIVELACIJE KABINE					
Poz.	Slika	KBP	Model	OE broj	RAPIDEX broj
1.		464 007 010 0	SERIJA 4 P, G, R, T	1430545	VESA0763



TRISTOP CILINDRI

Poz.	KBP	Model	Opis	OE broj	RAPIDEX broj
1.	925 431 033 0	SERIJA 2, 3, 4	24/24	571778	KOCN0543
2.	BS9510	SERIJA 4	24/14 PREDNJI	1133689	KOCN1867
3.	BS8500	SERIJA 4	24/30 ZADNJI	1912986	KOCN1868
4.	925 481 230 0	P, G, R, T	24/16 PREDNJI	1802409	KOCN2960
5.	BS9536	P, G, R, T	24/30 ZADNJI	1424306	KOCN1892

MEMBRANE TRISTOP CILINDRA

Poz.	KBP	Tip	Prečnik x Visina	RAPIDEX broj
1.	897 120 495 4	TIP 9	Ø128 x 31 mm	KOCN1555
2.	897 120 505 4	TIP 12 P	Ø139 x 31 mm	KOCN1259
3.	897 120 510 4	TIP 16 P	Ø156 x 35 mm	KOCN3087
4.	897 120 516 4	TIP 16 D	Ø158 x 43 mm	KOCN3086
5.	897 120 520 4	TIP 20 P	Ø128 x 31 mm	KOCN3089
6.	897 120 526 4	TIP 20 D	Ø168 x 38 mm	KOCN3088
7.	897 120 530 4	TIP 24 P	Ø179 x 33 mm	KOCN1231
8.	897 120 535 4	TIP 24 S	Ø179 x 40 mm	KOCN1224
9.	897 120 536 4	TIP 24 D	Ø179 x 45 mm	KOCN3125
10.	897 120 540 4	TIP 30 P	Ø199 x 35 mm	KOCN3095
11.	897 120 546 4	TIP 30 D	Ø200 x 44 mm	KOCN3094
12.	897 121 610 4	TIP 14 P	Ø139 x 28 mm	KOCN3085
13.	897 121 923 4	TIP 12 D	Ø162 x 43 mm	KOCN0926

ABS RELEJNI VENTILI

Poz.	Slika	KBP	Model	OE broj	RAPIDEX broj
1.		472 195 016 0	UNIVERZALNI	1934974	KOCN0551
2.		472 195 018 0	SERIJA 4 P, G, R, T	1518589	KOCN1164

ADAPTER KABEL ABS VENTILA

Poz.	Slika	KBP	Model	OE broj	RAPIDEX broj
1.		894 601 132 2	UNIVERZALNI	-	KOCN1154
2.		894 601 133 2	UNIVERZALNI	-	KOCN1156
3.		894 601 134 2	UNIVERZALNI	-	KOCN0251

EBS VENTILI

Poz.	Slika	KBP	Model	OE broj	RAPIDEX broj
1.		K020623N50	P, G, R, T	1879274	KOCN2066

ECAS ELEKTROMAGNETNI VENTIL

Poz.	Slika	KBP	Model	OE broj	RAPIDEX broj
1.		472 900 012 0	SERIJA 4	1105670	VESA0514

ECAS RUČNA KOMANDA - TELEKOMADA

Poz.	KBP	Model	Opis	OE broj	RAPIDEX broj
1.	446 056 146 0	SERIJA 4 P, G, R, T	F/A, R/AXLE	1506033	VESA0518



ELEKTRONIKA ECAS - CENTRALA

Poz.	KBP	Model	Opis	OE broj	RAPIDEX broj
1.	446 055 066 0	SERIJA 4	46 - PINSKI	1518019	VESA0654



SENZORI ABS

Poz.	KBP	Model	Opis	OE broj	RAPIDEX broj
1.	441 032 921 2	UNIVERZALNI	400 mm, SET, pod uglom	1784588	KOCN1147
2.	441 032 922 2	UNIVERZALNI	1000 mm, SET, pod uglom	1738458	KOCN1322
3.	441 032 963 2	UNIVERZALNI	350 mm, SET	1784590	KOCN0916
4.	441 032 905 0	UNIVERZALNI	350 mm, ravan	1784590	KOCN1652
5.	441 032 808 0	UNIVERZALNI	400 mm, pod uglom	1934568	KOCN1216
6.	441 032 938 2	SERIJA 4 P, G, R, T	2240 mm, SET	1353493	KOCN0748

PRODUŽNI KABEL SENZORA

Poz.	KBP	Opis	RAPIDEX broj
1.	449 712 008 0	DUŽINA 800 mm	KOCN1655
2.	449 712 018 0	DUŽINA 1800 mm	KOCN0891
3.	449 712 030 0	DUŽINA 3000 mm	KOCN1107
4.	449 712 051 0	DUŽINA 5100 mm	KOCN0719
5.	449 712 060 0	DUŽINA 6000 mm	KOCN0886
6.	449 712 120 0	DUŽINA 12000 mm	KOCN0973

PREKIDAČI PRITISKA

Poz.	Slika	KBP	Opis	OE broj	RAPIDEX broj
1.		441 009 101 0	UNIVERZALNI	-	VESA0642
2.		441 014 006 0	UNIVERZALNI	-	KOCN1658
3.		441 014 010 0	UNIVERZALNI	-	VESA0488
4.		441 014 501 0	UNIVERZALNI	-	KOCN2797
5.		441 014 025 0	UNIVERZALNI	1012085	VESA0674

SENZOR PRITISKA

Poz.	Slika	KBP	Model / Opis	OE broj	RAPIDEX broj
1.		441 044 101 0	UNIVERZALNI 10 bar	1738460	KOCN0752

SENZORI ECAS-a

Poz.	Slika	KBP	Model	OE broj	RAPIDEX broj
1.		441 050 008 0	SERIJA 4	1338343	VESA0777

SERVO CILINDRI KVAČILA

Poz.	Slika	KBP	Model	OE broj	RAPIDEX broj
1.		622199AM	SERIJA 3	1331770	KOCN0466
2.		974 010 001 0	SERIJA 4	1412317	MENJ0229
3.		1000178631AM	SERIJA P, G, R, T	1927825	KVAC0274
4.		629683AM	SERIJA P, G, R, T	1513717	KVAC0300

PRIMARNI CILINDRI KVAČILA

Poz.	Slika	Model	KBP	Opis / Odlivak	OE broj	RAPIDEX broj
1.		SERIJA P, G, R, T	1000179039AM	Ø24,0 mm	1800442	KVAC0273

CREVA VAZDUHA

Poz.	KBP	Opis	Dužina	Boja	RAPIDEX broj
1.	KG685091	SPIRALNO M16 x 1,5 mm	4,5 m	crveno	KOCN2940
2.	KG685087	SPIRALNO M16 x 1,5 mm	4,5 m	zuto	KOCN2939

SPOJNE GLAVE

Poz.	Slika	KBP	Opis	RAPIDEX broj
1.		452 802 007 0	DUOMATIC - BRZA, M16 x 1,5 mm	KOCN0743
2.		452 802 009 0	DUOMATIC - BRZA sa ABE, M16 x 1,5 mm	KOCN1044

SPOJNE GLAVE

Poz.	Slika	KBP	Opis	RAPIDEX broj
3.		452 803 005 0	DUOMATIC - BRZA, PRIKLJUČAK ABE, M16 x 1,5 mm	KOCN0521
4.		452 804 012 0	DUOMATIC - BRZA, VUČNO VOZILO, M16 x 1,5 mm	KOCN1043
5.		452 805 004 0	DUOMATIC - BRZA, M16 x 1,5 mm	KOCN0520
6.		952 200 021 0	M16 mm, CRVENA, PRIKOLICA	KOCN1345
7.		952 200 022 0	M16 mm, ŽUTA, PRIKOLICA	KOCN1346
8.		952 200 221 0	M16 mm, CRVENA, KAMION	KOCN1347

SPOJNE GLAVE				
Poz.	Slika	KBP	Opis	RAPIDEX broj
9.		952 200 222 0	M16 mm, ŽUTA, KAMION	KOCN1357
10.		952 201 001 0	SA FILTEROM, M16 mm, ŽUTA, max 8,5 bar	KOCN0827
11.		952 201 002 0	SA FILTEROM, M16 mm, CRVENA, max 8,5 bar	KOCN0826



CREVA VAZDUŠNE INSTALACIJE				
Poz.	Opis	Dužina	KBP	RAPIDEX broj
1.	4 x 1,0 mm	25 m	T 7300.15	KOCN3581
2.	5 x 1,0 mm	25 m	T 7300.27	KOCN0885
3.	6 x 1,0 mm	25 m	T 7300.01	KOCN3631
4.	8 x 1,0 mm	25 m	T 7300.02	KOCN3542
5.	9 x 1,5 mm	25 m	T 7300.14	KOCN0853
6.	10 x 1,0 mm	25 m	T 7300.03	KOCN4093
7.	12 x 1,5 mm	25 m	T 7300.04	KOCN3802
8.	15 x 1,5 mm	25 m	T 7300.05	KOCN1070
9.	18 x 2,0 mm	25 m	T 7300.20	KOCN1069
10.	NW 11 x 3,5 mm	40 m	T 7299.97	KOCN3777
11.	NW 13 x 6,0 mm	40 m	T 7299.98	KOCN3740
12.	NW 15 x 5,0 mm	40 m	T 7299.96	KOCN0902



SPOJNICE CREVA			
Poz.	KBP	Opis	RAPIDEX broj
1.	893 129 401 2	CREVO 11 x 3,5 mm, M16 x 1,5 mm	OSTA0257
2.	893 129 402 2	CREVO 11 x 3,5 mm, M22x1,5 mm	OSTA0256
3.	893 129 403 2	CREVO 13 x 6 mm, M16x1,5 mm	OSTA0255
4.	893 129 404 2	CREVO 13 x 6 mm, M22x1,5 mm	OSTA0254
5.	893 226 682 2	UTIČNICA VOSS NG8 WABCO	OPRE0209
6.	893 226 689 2	ADAPTER M16 VOSS SA 232 NA 230	OPRE0021
7.	893 226 690 2	ADAPTER M22 VOSS SA 232 NA 230	OPRE0022
8.	893 800 005 2	CREVO 8 x 1 mm, M22 x 1,5 R mm	OSTA0176
9.	893 800 009 2	CREVO 10 x 1 mm, M16 x 1,5 mm	OSTA2213
10.	893 803 890 0	CREVO10 x 1 mm, M22 x 1,5 mm	OSTA1249
11.	893 800 002 2	CREVO 12 x 1,5 mm, M16 x 1,5 mm	OSTA0476
12.	893 800 008 2	CREVO 12 x 1,5 mm, M22 x 1,5 mm	OSTA0485
13.	893 800 004 2	CREVO 15 x 1,5 mm, M22 x 1,5 mm	OSTA1087
14.	893 800 007 2	CREVO 8 x 1 mm, M12 x 1,5 mm	OSTA0483
15.	893 800 001 2	CREVO 8 x 1 mm, M16 x 1,5 mm	OSTA0482

SPOJNICE CREVA			
Poz.	KBP	Opis	RAPIDEX broj
16.	893 803 022 0	CREVO 6 x 1 mm, M12 x 1,5 mm	OSTA1170
17.	893 800 003 2	CREVO 16 x 2 mm, M22 x 1,5 mm	OSTA0484
18.	893 803 035 0	CREVO 6 x 2 mm, M10 x 1,5 mm	OSTA1171
19.	893 803 780 0	CREVO 15 x 2 mm, M22 x 1,5 mm	OSTA0262
20.	893 831 223 0	CREVO 6 x 1 mm, M12 x 1,5 mm, pod uglom	OSTA0477
21.	893 831 291 0	CREVO 8 x 1 mm, M12 x 1,5 mm, pod uglom	OSTA1570
22.	893 831 293 0	CREVO 8 x 1 mm, M16 x 1,5 mm, pod uglom	OSTA1136
23.	893 831 292 0	CREVO 8 x 1 mm, M22 x 1,5 mm, pod uglom	OSTA0480
24.	893 831 295 0	CREVO 12 x 1,5 mm, M16 x 1,5 mm, pod uglom	OSTA1764
25.	893 831 215 0	CREVO 15 x 1,5 mm, M16 x 1,5 mm, pod uglom	OSTA1901



KUTIJA SA SPOJNICAMA	
KBP	RAPIDEX broj
893 000 200 0	OSTA1115



SPOJNICE CREVA				
Slika	Poz.	Opis	KBP	RAPIDEX broj
	1.	4 mm	T 7820.00	KOCN1102
	2.	5 mm	T 7820.01	KOCN1101
	3.	6 mm	T 7820.02	KOCN1100
	4.	8 mm	T 7820.03	KOCN1099
	5.	10 mm	T 7820.04	KOCN1098
	6.	12 mm	T 7820.05	KOCN1097
	7.	15 mm	T 7820.06	KOCN1096
	8.	22 mm	T 7820.08	KOCN1095
	9.	4 mm	T 7830.00	KOCN1029
	10.	5 mm	T 7830.01	KOCN1710
	11.	6 mm	T 7830.02	KOCN1028
	12.	8 mm	T 7830.03	KOCN1027
	13.	10 mm	T 7830.04	KOCN1026
	14.	12 mm	T 7830.05	KOCN1025
	15.	15 mm	T 7830.06	KOCN1709
	16.	4 mm	T 7840.00	KOCN1022
	17.	5 mm	T 7840.01	KOCN1713
	18.	6 mm	T 7840.02	KOCN1021
	19.	8 mm	T 7840.03	KOCN1020
	20.	10 mm	T 7840.04	KOCN1019
	21.	12 mm	T 7840.05	KOCN1018
	22.	15 mm	T 7840.06	KOCN1714

ALAT ZA BRZE SPOJNICE					
Poz.	Slika	KBP	Opis	OE broj	RAPIDEX broj
1.		899 700 001 4	8 x 1,5 mm	-	OSTA0716
2.		899 700 002 4	12 x 1,5 mm	-	OSTA0717
3.		899 700 003 4	15 x 1,5 / 16 x 2	-	OSTA0718

PRIGUŠIVAČI ZVUKA					
Poz.	Slika	KBP	Opis	OE broj	RAPIDEX broj
1.		432 407 012 0	Ø87 x 62 mm	-	KOCN0746
2.		432 407 060 0	Ø69 x 56,5 mm	-	KOCN0858
3.		432 407 070 0	Ø69 x 53 mm	-	KOCN0859

RAPIDEX

TRADE



3

TEČNOST PROTIV SMRZAVANJA INSTALACIJA

Poz.	KBP	Opis	RAPIDEX broj
1.	830 702 087 4	WABCOTIL 1/1	ULJA0042
2.	830 702 090 4	WABCOTIL 200/1	ULJA0043

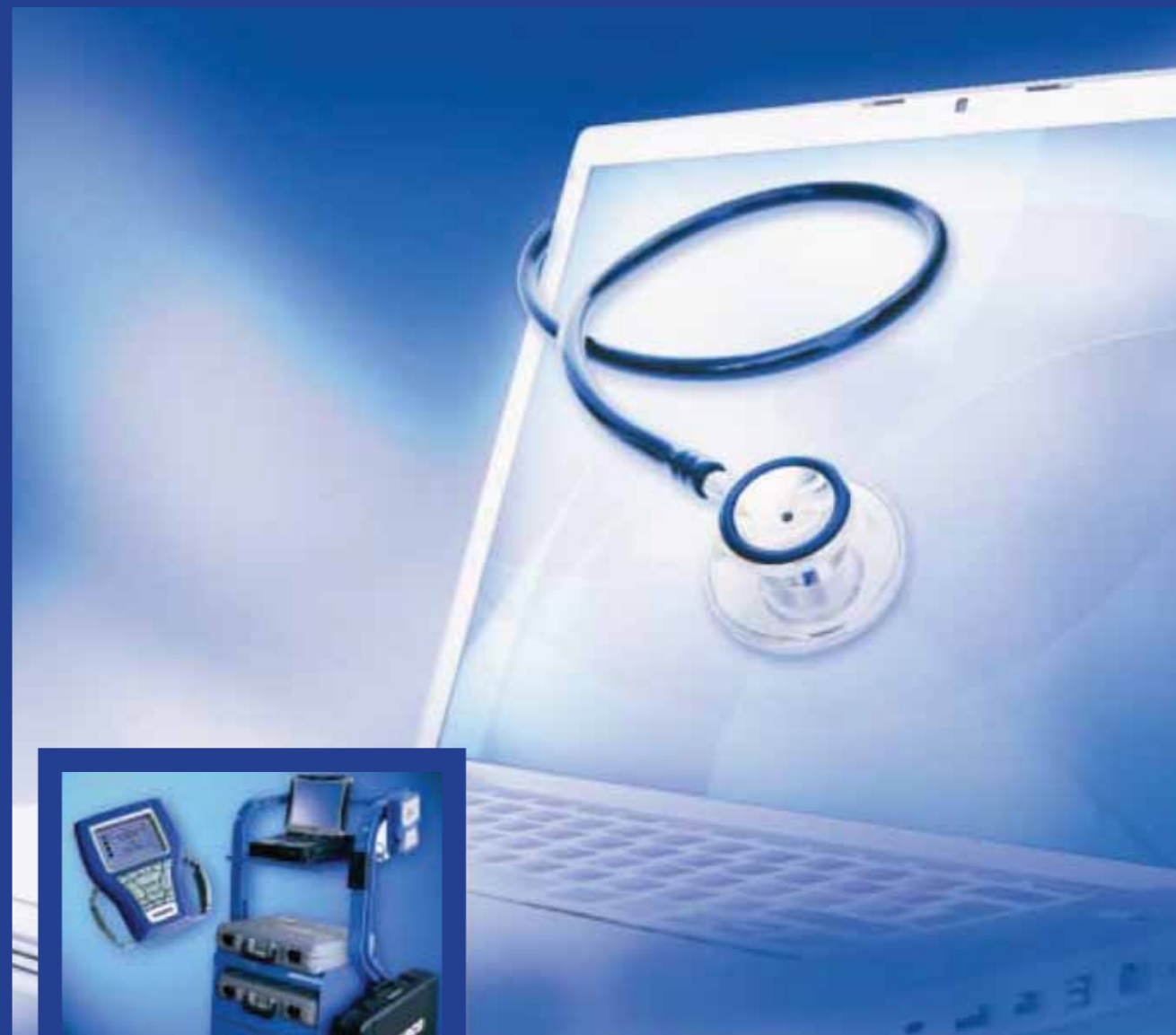

DIJAGNOSTIKA
Hardver & Softver

WABCO

Dok je ranijih godina za dijagnostiku svakog sistema na komercijalnim vozilima bio potreban poseban dijagnostički uređaj, danas je dovoljno posedovati JEDAN da bi se uspešno rešavali problemi kako različitih SITEMA tako i različitih proizvođača VOZILA

WABCO u svojoj ponudi raspolaže sa DVA RAZLIČITA dijagnostička sistema:

- WABCO SD sistem - WABCO SISTEMSKA DIJAGNOSTIKA
- WABCO & WÜRTH sistem.

Za svaku od ovih sistema nudimo neophodnu OPREMU, PROGRAME i što je velika retkost: OBUKU.



WABCO & WÜRTH - DIJAGNOSTIČKI SISTEM

Ovaj DIJAGNOSTIČKI UREĐAJ predstavlja najsavremeniju UNIVERZALNU DIJAGNOSTIČKU ALATKU na tržištu sa nebrojeno mnogo funkcija i mogućnosti kako za rad, tako i za PERSONALIZACIJU - prema potrebama samog korisnika.

Sam sistem se može dobiti u dve osnovne varijante:

- SA SD WABCO DIJAGNOSTIKOM
- BEZ SD WABCO DIJAGNOSTIKE

Dalje je moguća podela po delokrugu rada na:

- KOMPLETAN PAKET (SISTEMI KAMIONA, PRIKOLICE I BUS-a, LAKI TERETNI PROGRAM)
- KAMIONSKI PAKET
- PRIKOLIČNI PAKET
- BUS PAKET



WABCO & WÜRTH - DIJAGNOSTIČKI SISTEM

Sistemi na vozilima koji se mogu kontrolisati sa ovim uređajima su:

- KOČIONI SISTEM
- MENJAČ
- MOTOR
- ELEKTRIČNE INSTALACIJE
- GREJANJE I HLAĐENJE
- UPRAVLJANJE I VEŠANJE



Zbog stalnog usavršavanja i dopunjavanja teško je definisati krajnje mogućnosti rada ovog uređaja te zbog toga  omogućava proveru mogućnosti uređaja - PREZENTACIJU SVAKOM ZAINTERESOVANOM KLIJENTU kod njega na vozilima koja klijent odabere.

SVI ZAINTERESOVANI MOGU ZAKAZATI BESPLATNU PREZENTACIJU PREKO FIRME „RAPIDEX TRADE“ TE ĆE STRUČNI LJUDI  UBRZO STUPITI U KONTAKT SA ZAINTERESOVANIMA.

Više informacija se može dobiti na: <http://www.wabcowuerth.com>



WABCO **SD - SISTEMSKA DIJAGNOSTIKA**

Za SD dijagnostiku WABCO sistema koristi se sledeća oprema:

- KOFER ZA PROVERU PNEUMATSKE KOČIONE INSTALACIJE
- KOFERI SA DIJAGNOSTIČKOM OPREMOM
- PAKETI DIJAGNOSTIČKIH PROGRAMA

WABCO SD - OPREMA

• **Kofer za dijagnostiku pneumatske kočione instalacije**



W: 435 002 007 0
R: KOCN1763

• **Kofer za dijagnostiku prikoličnih sistema** **W: 446 301 023 0** **R: KOCN0837**

Sadržaj kofera za dijagnostiku sistema na prikolicama i poluprikolicama:

- Diagnostic Interface
- Trailer Standardkabel
- CAN Adapter
- CAN Adapterkabel
- VCS I
- VCS II
- TEBS C / D



• **Kofer za dijagnostiku sistema na kamionima** **W: 446 301 025 0** **R: KOCN1764**

Sadržaj kofera za dijagnostiku sistema na kamionima:

- Adapter 35-pol EPS
- Kabel MB Actros/Citaro
- Kabel EBS Euro Neoplan
- Kabel MAN-TGA
- Kabel EBS IVECO Stralis
- Kabel ABS-D
- Kabel EBS DAF
- Kabel Actros MPII (OBD II)
- Kabel ECAS
- Kabel 15-pol. DAF, Scania, MAN (OBD II)
- Kabel ABS D/E ISO 9141



• **Kofer za dijagnostiku sistema na autobusima** **W: 446 301 026 0** **R: KOCN1765**

Sadržaj kofera za dijagnostiku sistema na autobusima:

- Diagnostic Interface
- Kabel MB Actros/Citaro
- Kabel EBS Euro Neoplan
- Kabel MAN-TGA
- Kabel Setra NF 315 MTS
- Kabel Actros MPII (OBD II)
- Kabel 15-pol. DAF, Scania, MAN (OBD II)



• **Paketi dijagnostičkih programa:**

- PAKET FULL (KAMIONI, AUTOBUSI, PRIKOLICE) **W: 246 301 900 0**
R: OPRE0098
- PAKET PRIKOLICA - POLUPRIKOLICA **W: 246 301 901 0**
R: OPRE0524
- PAKET AUTOBUSI **W: 246 301 902 0**
R: OPRE0525
- PAKET KAMIONI **W: 246 301 904 0**
R: OPRE0526



RAPIDEX TRADE svake godine u saradnji sa WABCO-m organizuje **OBUKU - TRENING** za servisere WABCO sistema.

Obuka se odvija u **EDUKATIVNOM CENTRU** u Novom Sadu, Novosadski put 160.

Do sada je obuku uspešno završilo nekoliko generacija polaznika, koje se uspešno nose sa svakodnevnim problemima kvarova na vozilima širom Srbije i zemalja u okruženju.

Predavač WABCO TRENER gospodin Berislav Babić



Detalji sa obuke u edukativnom centru



- **PROIZVODI i REŠENJA** za komercijalna vozila
- **PRIMENA** za proizvodnju vozila
- **ORIGINALNI KVALITET** za Popravku

4.0 KOMPONENTE KOČIONOG SISTEMA



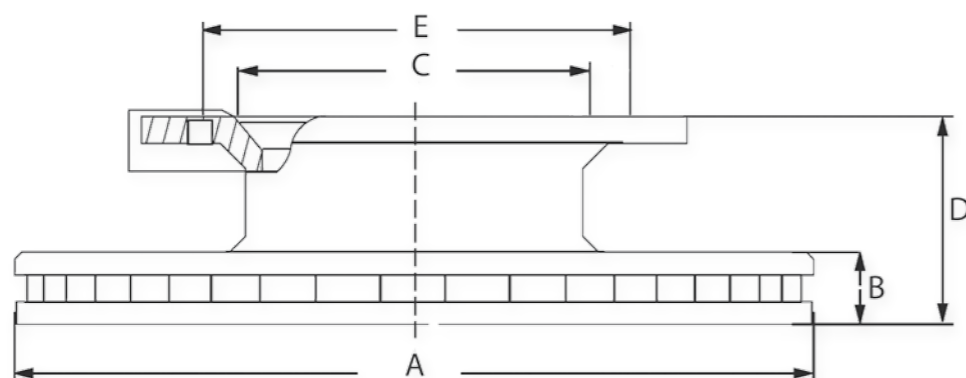

4.0 KOMPONENTE KOČIONOG SISTEMA

4.1	Disk kočnica	82
4.2	Kočione pločice	83
4.3	Čeljusti kočnica	84
4.4	Doboši kočnica	85
4.5	Kočione obloge	86
4.6	Šteleri kočnica	87
4.7	Glavčine točka, ležajevi i semerinzi	88
4.8	Vijci i navrtke	91

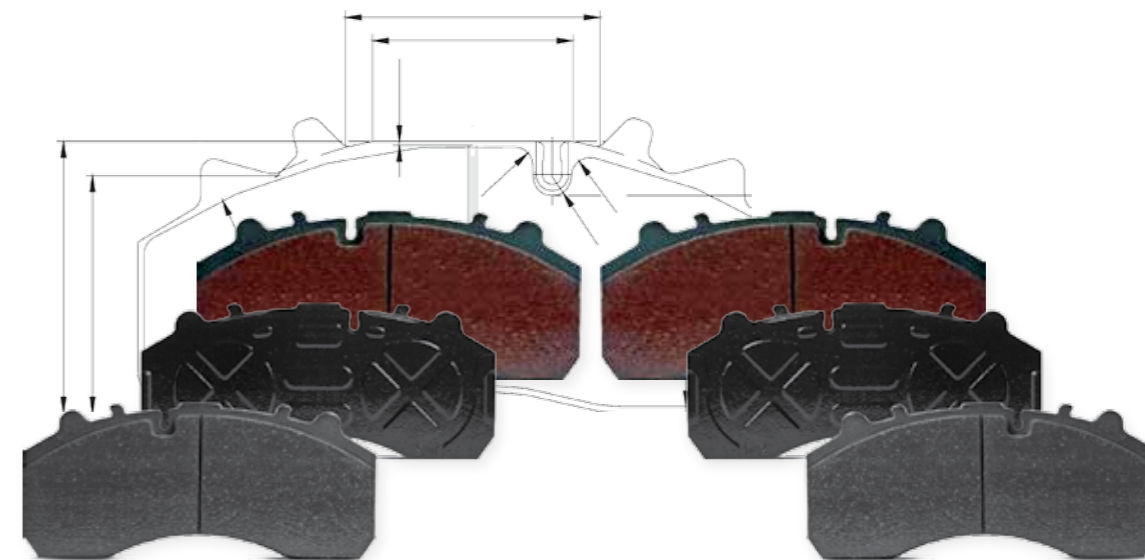

DISK KOČNICA									
	Poz.	Model vozila	OE broj		RAPIDEX broj				
	1.	Seriya 4, P, G, R, T Bus serija 4	1402272	KOCN0123					
	A (mm)	Bmin (mm)	Bmax (mm)	C (mm)	D (mm)	E (mm)	Rupe	Pozicija	
430	37	45	208	131	237	10 x M16 x 1,5 mm	Pr/Zd		



KOČIONE PLOČICE						
	WVA broj		Dimenzije (mm)			RAPIDEX broj
		29202	Knorr	247,3	109,5	30
Poz.	Model vozila		OE broj			
1.	SERIJA 4, P, G, R, T		1734529			

SENZORI ISTROŠENOSTI PLOČICA					
Slika	Poz.	Model vozila	Dimenzije	OE broj	RAPIDEX broj
	1.	94-124, BUS 96-	282 mm	1388953	KOCN1199



ČELJUSTI

Poz.	Model vozila	Tip čeljusti	Proizvođač	KBP	OE broj	RAPIDEX broj
1.	124	22,5	KNORR	SN7208RC/K003813	1756385	KOCN1399
2.	124	22,5	KNORR	SN7218RC/K003814	1756384	KOCN1400
3.	124 / BUS	22,5	KNORR	SB7203RC/K003803	1363748	KOCN1395
4.	124 / BUS	22,5	KNORR	SB7213RC/K003804	1363749	KOCN1394

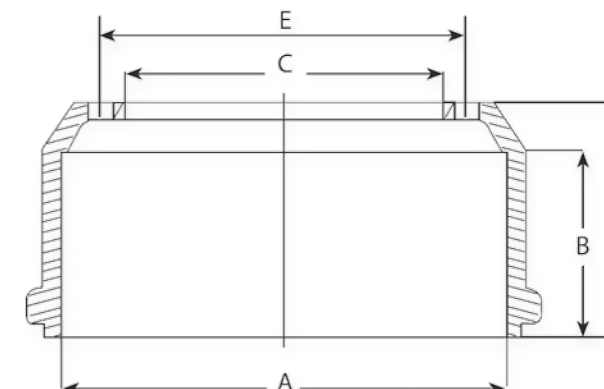

DOBOŠI KOČNICA

Poz.	Model vozila	A (mm)	B (mm)	C (mm)	D (mm)	E (mm)	Rupe	Pozicija	OE broj	RAPIDEX broj
1.	Serija 2, 3 88-96, BUS Serija 4 96-	413	216	295	296	335	10 x Ø23,5 mm, 2 x Ø13 mm 3 x M12 x 1,75 mm	Zd	360572 305406	KOCN0535
2.	Serija 2, 3 88-96, BUS	413	213	298	275	335	10 x Ø23 mm, 3 x M12 x 1,75 mm	Pr/Zd	1414153	KOCN3101
3.	Serija 2, 3, BUS	413	270	295	320	335	10 x Ø23,5 mm, 3 x M12 x 1,75 mm	Zd	1414435	KOCN1423
4.	Serija 4, BUS 96-	413	187	295	263	335	10 x Ø23,5 mm, 3 x M12 x 1,75 mm	Pr/Zd	1414152	KOCN1424

SERIJA 3 113, 143 / SERIJA 4 114, 124, 144, 164							
	WVA broj	∅ mm				OE broj	RAPIDEX broj
	19931	413	178	235	16	1535248 551123	
	19931 1900						KOCN1648
	19931 2000						KOCN1662
Model vozila							
SERIJA 3 113, 143 SERIJA 4 114, 124, 144, 164							

SERIJA 2, 3, 4 / BUS							
	WVA broj	∅ mm				OE broj	RAPIDEX broj
	19932	413	203	235	16	511124	
	19932 1900						KOCN1663
	19932 2000						KOCN1664
19932 2100						KOCN1844	
Model vozila							
SERIJA 2, 3, 4, SCANIA BUS							

SERIJA 3 93, 113, 123, 143 / SERIJA 4 94, 114, 124, 144, 164							
	WVA broj	∅ mm				OE broj	RAPIDEX broj
	19933	413	254	193	12	1 535 250	
	19933 1900						KOCN1666
	19933 2000						KOCN1667
Model vozila							
SERIJA 3 93, 113, 123, 143 SERIJA 4 94, 114, 124, 144, 164							

NITNE ZA OBLOGE					
	Model vozila	Dimenzije	Set	KBP	RAPIDEX broj
	SVI MODELI	Ø6,65 x 18 mm	100 kom	96000 0074	KOCN1842

ŠTELERI KOČNICA							
Slika	Poz.	Model vozila	Broj zuba	Osnovno rastojanje (mm)	Haldex broj	OE broj	RAPIDEX broj
	1.	SERIJA 4, P, G, R, T, BUS	10	165	-	1448115	KOCN1902
	2.	SERIJA 4, P, G, R, T, BUS	10	165	-	1448114	KOCN2215
	3.	SERIJA 4 94, 114, 124	10	145	72660C	1112833	KOCN1486
	4.	SERIJA 4 94, 114, 124	10	145	72662C	1112831	KOCN1487

GLAVČINE TOČKA

Poz.	Model vozila	OE broj	RAPIDEX broj
1.	SERIJA 4, P, G, R, T	1414154	OSOV0270
2.	SERIJA 4, P, G, R, T	1480933	OSOV0271
3.	SERIJA 4, P, G, R, T	1382884	OSOV0272
4.	SERIJA P, G, R, T	1800283	OSOV0273

LEŽAJEVI

Poz.	Model vozila	Dimenzije (mm)			KBP	OE broj	RAPIDEX broj
1.	SERIJA 2, 3	147	90	41,7	VKHB2029	1524625	OSOV0099
2.	SERIJA 2, 3	100	45	38,25	32309 VKHB2004	1362149	OSOV0416
3.	SERIJA 2,3	130	75	34,8	VKHB2033	1410207	OSOV0788
4.	SERIJA 2, 3	170	110	38	32022X VKHB2281	362226	OSOV0635
5.	SERIJA 2, 3, 4	130	75	41	33215 VKHB2406S	260998	OSOV0106
6.	SERIJA 4	130	70	43	VKHB2024	322748	OSOV0092
7.	SERIJA 4	147	90	40	KHM218248 VKHB2407S	291060	OSOV0107
8.	SERIJA 3, 4, P, G, R, T	127	68	115	VKBA5314	1413785	OSOV0094



SEMERINZI

Poz.	Model vozila	Dimenzije (mm)			OE broj	RAPIDEX broj
1.	SERIJA 3	137	162	15/12	370074	OSOV0456
2.	SERIJA 3, 4	142	170	15/20	1409838	OSOV0696
3.	SERIJA 4, 94, 114, 124, 144, 164, P, G, R, T	142	170	15/16	1534012	OSOV0691
4.	SERIJA 4, 94, 114, 124, 144, 164, P, G, R, T	85	105	12/18	1502384	MOTO1038
5.	SERIJA 3, 4, P, G, R, T	75	100	14	1409890	OSOV0319

VIJCI I NAVRTKE

Poz.	Model vozila	Naziv	Dimenzije (mm)			Navoj	OE broj	RAPIDEX broj
1.	SERIJA 4, P, G, R, T	VIJAK	86	74	53	7/8"-11	123250	OSOV0842
		NAVRTKA				7/8"-11	318690	OSOV0361
2.	SERIJA 4, P, G, R, T	VIJAK	97	86	61	7/8"-11	1368693	OSOV0360
		NAVRTKA				7/8"-11	318690	OSOV0361
3.	SERIJA 4, P, G, R, T	VIJAK	109	98	71	7/8"-11	272853	OSOV0827
		NAVRTKA				7/8"-11	318690	OSOV0361
4.	SERIJA 4, P, G, R, T	VIJAK	80	68	44	7/8"-11	1368690	OSOV0827
		NAVRTKA				7/8"-11	318690	OSOV0361

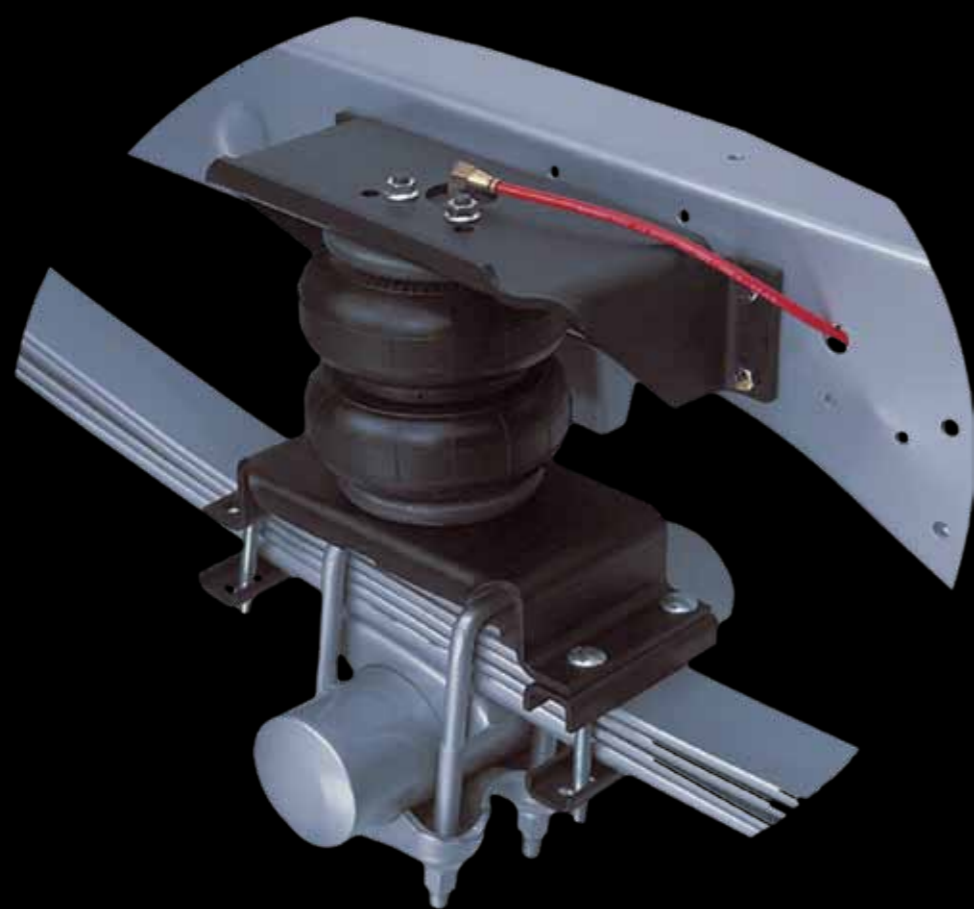
5.0 ELEMENTI OGIBLJENJA I UPRAVLJANJA



5.0 ELEMENTI OGIBLJENJA I UPRAVLJANJA

5.1	Amortizeri	94
5.2	Vazdušni jastuci	97
5.3	Gibnjevi	100
5.4	Delovi stabilizatora	103
5.5	Delovi rukavca	104
5.6	Spone i delovi spona	105
5.7	Uporne spone	108
5.8	V spone	109

AMORTIZERI - TIPOVI VEZA

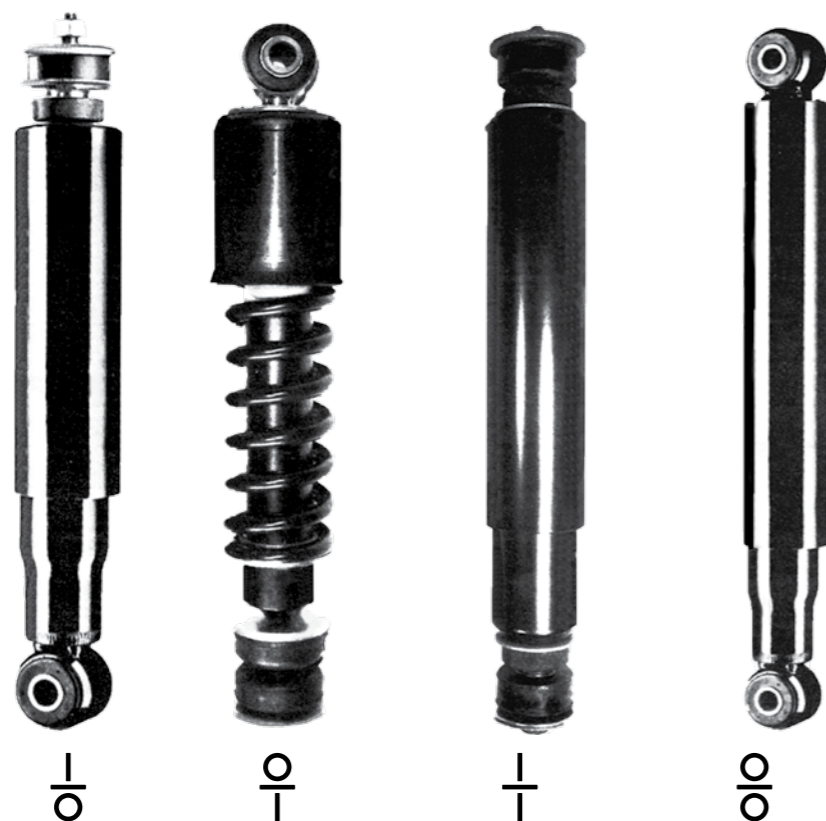

LEGENDA:

SIMBOL	ZNAČENJE	SIMBOL	ZNAČENJE
	VEZA OKO - OKO		AMORTIZER PREDNJE OSOVINE
	VEZA OKO - VIJAK		AMORTIZER ZADNJE OSOVINE
	VEZA VIJAK - OKO		PREDNJA I ZADNJA OSOVINA
	VEZA VIJAK - VIJAK		AMORTIZER KABINE - PREDNJI
	VEZA OKO - VILJUŠKA		AMORTIZER KABINE - ZADNJI
	AMORTIZER VOLANA		AMORTIZER KABINE



AMORTIZERI

Poz.	Model vozila	Osovina	Tip veze	OE broj	Sachs broj	RAPIDEX broj
1.	Serija 3, Serija 4, Serija P, R, T			1371448	125 598	AMOR0123
2.	Serija 3, Serija 4, Serija P, R, T			1421062	125 997	AMOR0353
3.	Serija 3, Serija 4, Serija P, R, T			1420474	125 998	AMOR0354
4.	Serija 3, Serija 4, Serija P, R, T			1478507	310 786	AMOR0095
5.	Serija 4, Serija P, R, T			1438527	311 892	AMOR0010
6.	Serija 3, Serija 4, Serija P, R, T			1478506	131 475	AMOR0011
7.	Serija 3, Serija 4, Serija P, R, T			1401877	131 543	AMOR0012
8.	94, 114, 124, 144, 164, Serija P, G, R, T			1519630	131 475	AMOR0522
9.	94, 114, 124, 144, 164, Serija P, G, R, T			1519632	311 893	AMOR0544
10.	BUS			1523287	300 024	AMOR0482





AMORTIZERI - KABINE

Poz.	Model vozila	Mesto ugradnje	Tip veze	Monroe broj	OE broj	RAPIDEX broj
1.	93, 113, 143			CB0065	1331620	AMOR0473
2.	93, 113, 143		jastuk	CB0066	1331635	AMOR0476
3.	94, 114, 124, 144, 164			CB0009	1381906	AMOR0073
4.	94, 114, 124, 144, 164, Serija P, R			CB0010	1 381 904	AMOR0074
5.	94, 114, 124, 144, 164		jastuk	CB0030	1381919	AMOR0018
6.	94, 114, 124, 144, 164			CB0058	1363120	AMOR0077
7.	94, 114, 124, 144, 164			CB0059	1349844	AMOR0078
8.	94, 114, 124, 144, 164		jastuk	CB0067	1349840	AMOR0079
9.	94, 114, 124, 144, 164, Serija P, R		jastuk	CB0074	1592468	AMOR0081
10.	94, 114, 124, 144, 164, Serija P, R			CB0078	1502470	AMOR0366
11.	94, 114, 124, 144, 164, Serija P, R		jastuk	CB0130	312465	AMOR0384
12.	94, 114, 124, 144, 164, Serija P, R			CB0134	1495642	AMOR0386

GASNI AMORTIZERI

Poz.	Model vozila	Dužina L (mm)	Sila F (N)	SE-M broj	OE broj	RAPIDEX broj
1.	114, 144	486	250	8390	1306492	AMOR0148
2.	124, 144	210	100	8392	-	AMOR0149

3691NP01				
Broj proizvođača dela	OE broj	Primena / Opis	RAPIDEX broj	
Contitech 3691NP01	1543691	Serija 4	VESA1977	
Fabio 343691-C				

4813NP07				
Broj proizvođača dela	OE broj	Primena / Opis	RAPIDEX broj	
Contitech 4813NP07	1314906	Serija 3 zadnja osovina	VESA1638	
Fabio 344813-7C				

4913NP02				
Broj proizvođača dela	OE broj	Primena / Opis	RAPIDEX broj	
Contitech 4913NP02	1379392	Serija 4 zadnja osovina	VESA1639	
Fabio 344913-2C				

4913NP04				
	Broj proizvođača dela	OE broj	Primena / Opis	RAPIDEX broj
	Contitech 4913NP04	1379393	Serija 4 zadnja osovina	VESA1626
	Fabio 344913-2S			

1386199				
	Broj proizvođača dela	OE broj	Primena / Opis	RAPIDEX broj
	Airtech 36199P	1386199	Serija 4 Serija P, G, R, T	VESA1864
	Fabio 346199-S			

1440301				
	Broj proizvođača dela	OE broj	Primena / Opis	RAPIDEX broj
	Airtech 330301K	1440301	Serija 4 Serija P, G, R, T	VESA1788
	Fabio 3440301-C			

1440303				
	Broj proizvođača dela	OE broj	Primena / Opis	RAPIDEX broj
	Airtech 331114K	1440303	Serija 4, Serija P, G, R, T	VESA1908
	Fabio 3440303-C			

1440305				
	Broj proizvođača dela	OE broj	Primena / Opis	RAPIDEX broj
	Airtech 330305K	1440305	Serija 4, Serija P, G, R, T	VESA1789
	Fabio 3440305-C			

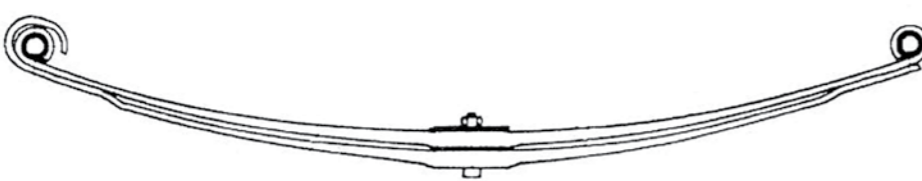
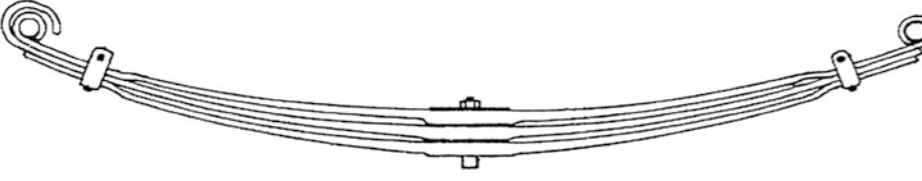

SERIJA 3, SERIJA 4 (prednja osovina)

Poz.	Model vozila	Opterećenje (t)	Širina (mm)	Broj listova x debljina lista (mm)	Dužina Lx/Ly (mm)	OE broj	RAPIDEX broj
1.	SERIJA 3, SERIJA 4	7,5	90	2 x 32	910/910	353174	VESA0266
							
2.	SERIJA 3, SERIJA 4	8,5	90	3 x 29	910/910	1300566	VESA0264
							

SERIJA P, G, R, T (prednja osovina)

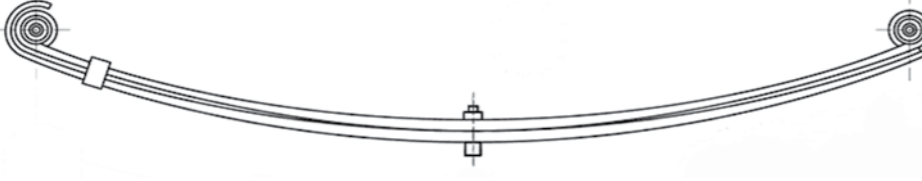

Poz.	Model vozila	Opterećenje (t)	Širina (mm)	Broj listova x debljina lista (mm)	Dužina Lx/Ly (mm)	OE broj	RAPIDEX broj
3.	SERIJA P, G, R, T	-	90	2 x 32	910/910	1528206	VESA2045
							

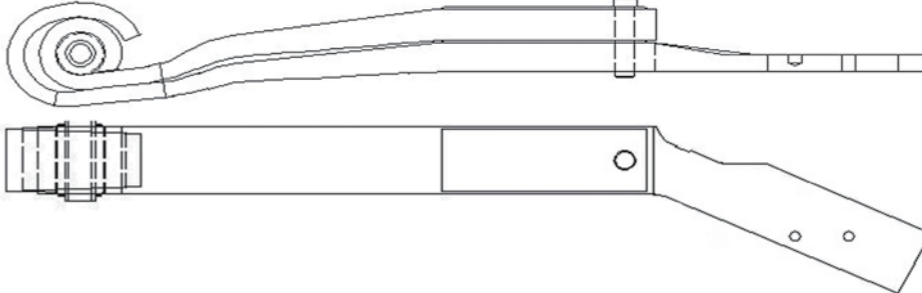
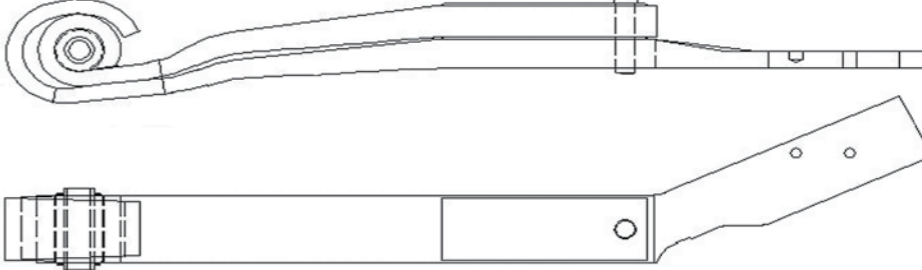
SERIJA 3, SERIJA 4 (zadnja osovina)

Poz.	Model vozila	Opterećenje (t)	Širina (mm)	Broj listova x debljina lista (mm)	Dužina Lx/Ly (mm)	OE broj	RAPIDEX broj
4.	SERIJA 3, SERIJA 4	-	100	1 x 47 1 x 44	707/410	1421061	VESA0265
							
5.	SERIJA 3, SERIJA 4	-	100	1 x 47 1 x 44	707/410	1421060	VESA0267
							

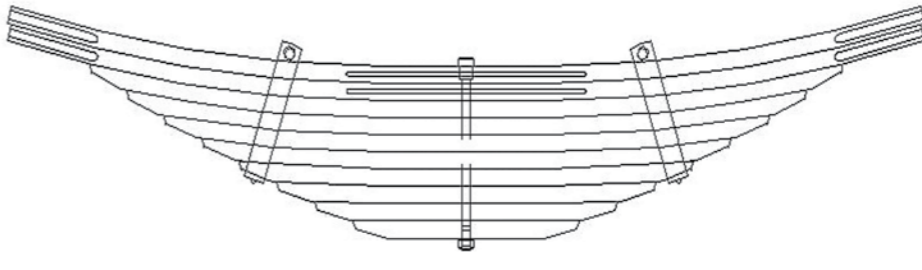
SERIJA 4, 94, 124, 144 (zadnja osovina)

Poz.	Model vozila	Opterećenje (t)	Širina (mm)	Broj listova x debljina lista (mm)	Dužina Lx/Ly (mm)	OE broj	RAPIDEX broj
6.	SERIJA 4, 94, 124, 144	26,3	90	10 x 25	795/795	1398987	VESA0268
							

ČAURE						
Slika	Poz.	Model vozila	Dimenzije d x D x h (mm)	SE-M broj	OE broj	RAPIDEX broj
	1.	Seriya 3, Seriya 4, Seriya P, G, R, T	M28 x 4 / 36 / 90	8266	128680	VESA2323
	2.	Seriya 3, Seriya 4, Seriya P, G, R, T	M28 x 4 / 166,5	8265	128681	VESA1038

DELOVI STABILIZATORA							
Slika	Pozicija	Model vozila	Mesto ugradnje	Dimenzije d x D x h (mm)	SE-M broj	OE broj	RAPIDEX broj
	1.	Seriya 4 08/96→	PO/ ZO	50 x 71 x103	8011	0 228 483	VESA0998
	2.	Seriya 4 08/96→	PO	40 x 56 x 122	8012	0 213 604	VESA0999
	3.	Seriya 4 08/96→	PO	-	9132	0228483S	VESA1799
	4.	Seriya P, G, R, T	PO	-	9137	0213604S	VESA2059



DELOVI RUKAVACA				
Slika	Poz.	Model vozila	OE broj	RAPIDEX broj
	1.	SERIJA 4 114, 124, 94, T114, T124	550284	VESA0148

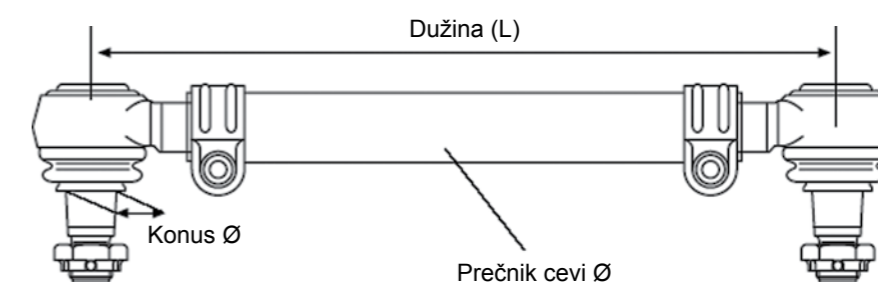

SPONE				
Poz.	Model vozila	Opis	OE broj	RAPIDEX broj
1.	SERIJA 4 (94,114, 124) 1996→, SERIJA P, R, T 2001→	Dužina: 420 (mm) Ø Cevi: 40 (mm) Ø Konusa: 30/26 (mm)	1394884	VESA0918
2.	SERIJA 4 (94,114, 124) 1996→	Dužina: 435 (mm) Ø Cevi: 38 (mm) Ø Konusa: 30 (mm)	1759691 1343283	VESA0093
3.	SERIJA 4 (94,114, 124) 1996→, SERIJA P, R, T 2001→	Dužina: 1054 (mm) Ø Cevi: 52 (mm) Ø Konusa: 30 (mm)	1379071 1356055 1384025	VESA2024

SPONE				
Poz.	Model vozila	Opis	OE broj	RAPIDEX broj
4.	SERIJA 4 (94, 114, 124) 1996→, SERIJA P, R, T 2001→	Dužina: 1059 (mm) Ø Cevi: 52 (mm) Ø Konusa: 30 (mm)	1384027 1769597	VESA0737
5.	SERIJA 4 (94, 114, 124) 1996→, SERIJA P, R, T 2001→	Dužina: 1743 (mm) Ø Cevi: 50 (mm) Ø Konusa: 30 (mm)	1409918 1501030 1723895 1737683 1897335 1385251	VESA2025
6.	SERIJA 4 (94, 114, 124) 1996→, SERIJA P, R, T 2001→	Dužina: 1743 (mm) Ø Cevi: 62 (mm) Ø Konusa: 30 (mm)	1361413 1897333 1395614 1734019	VESA0454

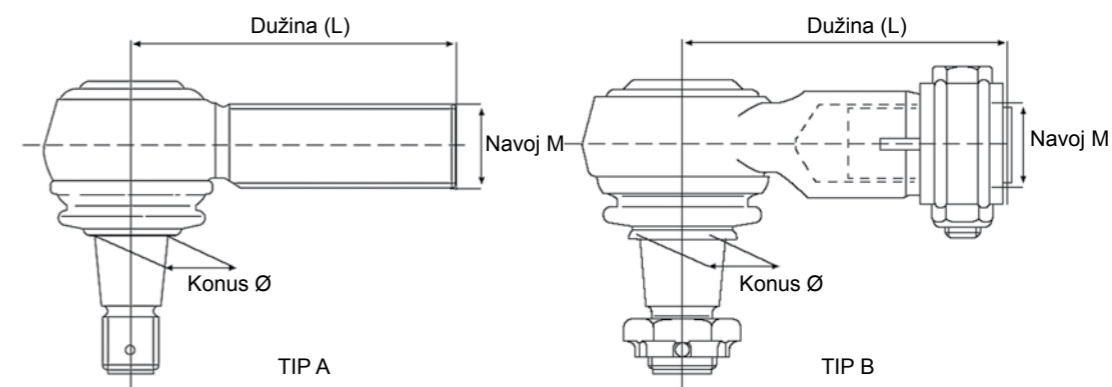

DELOVI SPONA							
Poz.	Model vozila	Dužina L (mm)	Konus Ø (mm)	Navoj M (mm)	Tip A/B	OE broj	RAPIDEX broj
1.	114, 124	55	-	M12 x 1.75 ∩	B	1384897	MENJ1066
2.	114, 124	55	-	M12 x 1.75 ∩	B	1384898	MENJ1065
3.	94, 114, 124, 144, 164	120	30	M30 x 1.5 ∩	A	1738380	VESA2023
4.	94, 114, 124, 144, 164	120	30	M30 x 1.5 ∩	A	1738381	VESA2022

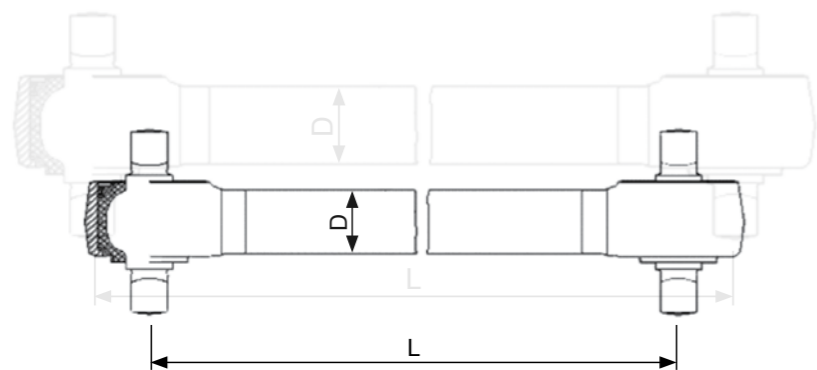

UPORNE SPONE							
Poz.	Model vozila	L (mm)	D (mm)	Reparatur set	Lemförder broj	OE broj	RAPIDEX broj
1.	SERIJA 4, SERIJA P, G, R, T	752	48	-	21458 02	1393298	VESA2052

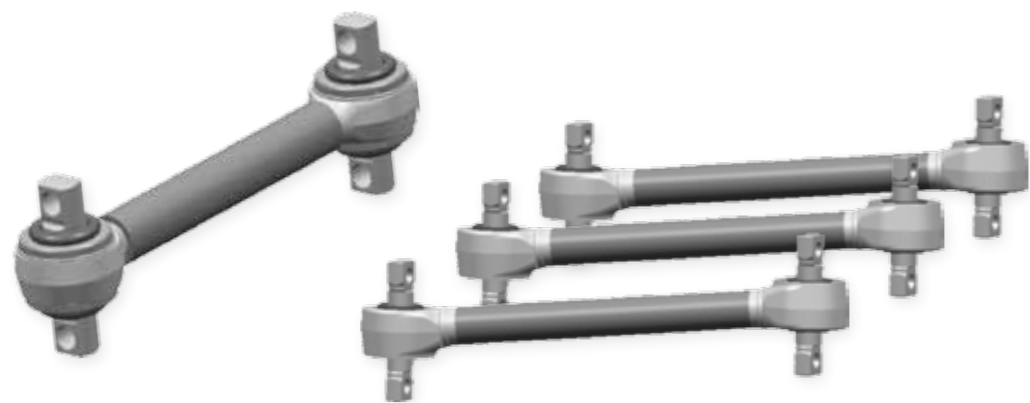

V SPONE							
Poz.	Model vozila	L (mm)	D (mm)	Reparatur set	Lemförder broj	OE broj	RAPIDEX broj
1.	SERIJA P, G, R, T	613,2	46	-	29387 01	1722582 1440028	VESA2055

6.0 KABINA I DELOVI KABINE



6.0 KABINA I DELOVI KABINE

6.1	Delovi kabine	112
6.2	Ogledala i delovi ogledala	129
6.3	Cilindri i pumpe za dizanje kabine	130
6.4	Elementi za oslanjanje kabine	131
6.5	Uređaji za pranje vetrobranskog stakla	134
6.6	Mehanizam vrata	135



KARO0224
1381480



KARO0226
1366384

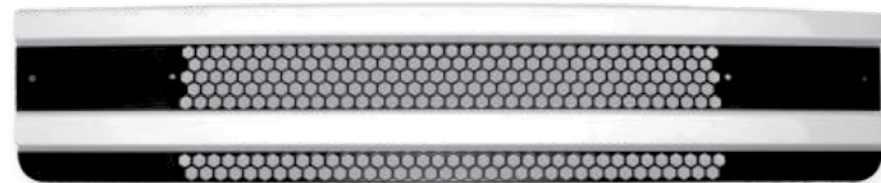

KARO0225
1381479



KARO0222
1543635



KARO0223
1543634



RASV1031
1431257



RASV1030
1431256



RASV0989
1529071



RASV0988
1529070



KARO0227
1324598



KARO0228
1400213



KARO0229
1324597



KARO0231
1382728



KARO0232
1381566



KARO0282
1538385



KARO0283
1538384



KARO0235
1381565



KARO0236
1382727



KARO0237
1383609



KARO0238
1397570



KARO0233
1726851



KARO0243
1381563



KARO0240
1401929



KARO0241
1371757



KARO0242
1371758



KARO0239
1366832





KARO0244
1364666



KARO0794
1517650



KARO0247
1390074



KARO0251
1354594



KARO0249
1515194



KARO0253
1535045



KARO0254
1535049



KARO0245
1364665



KARO0795
1517649



KARO0248
1390075



KARO0252
1354593



KARO0250
1515195



KARO0796
1370108



KARO0797
1386960



KARO0798
1537675



KARO0799
1386957



KARO0800
1386959



KARO0801
1370107



KARO0802
1401931



KARO0803
1371754



KARO0804
1397571



KARO0805
1515190





KARO0261
1408465
PREDNJI DESNI - ZADNJI LEVI



KARO0262
1408466
PREDNJI LEVI - ZADNJI DESNI



KARO0806
1387547



KARO0807
1335677



KARO0808
1335676



KARO0255
1544331



KARO0809
1387542



KARO0256
1544330



SVI DELOVI SU UGRADLJIVI U SERIJE L I R



KARO0258
1357602



KARO0259
1395276



KARO0263
1357600



KARO0260
1383858



KARO0264
1357599



SVI DELOVI SU UGRADLJIVI U SERIJE L I R



KARO0810
1785531



KARO1019

KARO0257
1496659



KARO0278
1431923



KARO0279
1431922



KARO0280*
1431921



KARO0281*
1431920



KARO0275*
1459141



KARO0276*
1459142



KARO0811
1727992



KARO0277*
1536807



KARO0812
1727991



* ODGOVARA ZA SERIJU R CP KABINA





KARO0821
1535039



KARO0822
1535040



KARO0293
1498180



KARO0298 L+D
1535052



KARO0292
1498179



KARO0299 L+D
1535048



KARO0823
1779119



KARO0824
1779118



KARO0297
1501343



KARO0296
1501342



KARO0294
1512424



KARO0295
1512423



KARO0282
1538385



KARO0268
1451246



KARO0283
1538384



KARO0825
1856474



KARO0265
1466032



KARO0266
1466031



KARO0826
1856475



KARO0277
1536807

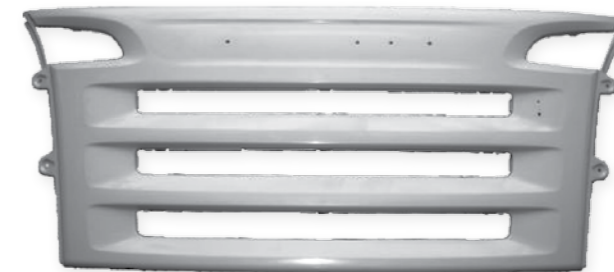

KARO0274
1748085



KARO0269
1459133



KARO0270
1459134



KARO0271
1459135



KARO0272
1459145





KARO0827
1543609



KARO0828
1543608



KARO0829
1856472



KARO0830
1856473



KARO0831
1438564



KARO0832
1438563



KARO0833
1858803



KARO0834
1466035



KARO0835
1466034



KARO0836
1543607



KARO0837
1743177



KARO0269
1459133



KARO0270
1459134



KARO0838
1459146





KARO1399
1872158



KARO1400
1872160



KARO1401
1871667



KARO1396
1923745



KARO1398
1873209



KARO1397
1923744



KABI0749



SERIJA 4 R

Poz.	Naziv	OE broj	RAPIDEX broj
1.	SUNCOBRAN	1769452	KABI0749



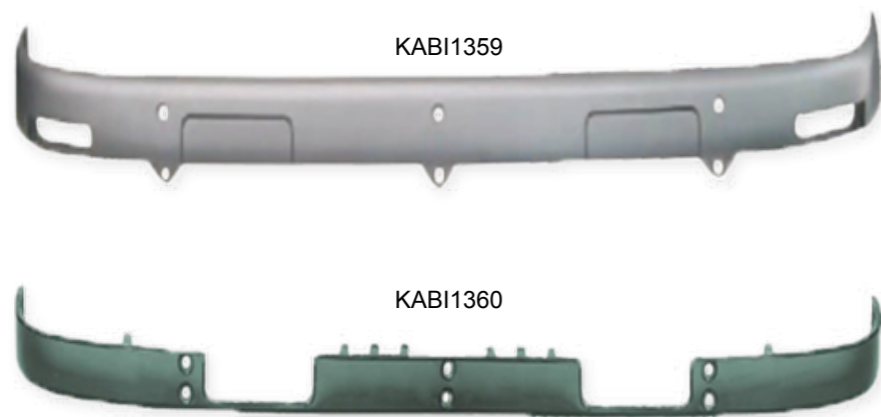

SERIJA R

Poz.	Naziv	OE broj	RAPIDEX broj
1.	SUNCOBRAN GORNJI DEO	1355656	KABI1359
2.	SUNCOBRAN DONJI DEO	1355655	KABI1360

SERIJA 3 (1981 - 1996)



OE broj	MEKRA broj	Opis	Položaj	Grejač	Dimenzije (mm)	RAPIDEX broj
316920	56.1561.110H		◀ ▶		258 x 152 x 30	KABI0356
316918	40.1561.105H		◀ ▶		253 x 150 x 3	KABI0354

SERIJA 4, R, P, T (1996 - ...)



OE broj	MEKRA broj	Opis	Položaj	Grejač	Dimenzije (mm)	RAPIDEX broj
1 723 518	59.4002.300H		◀		530 x 340 x 120	KABI0321
1 723 519	59.4002.400H		▶		530 x 340 x 120	KABI0546
1 346 378	15.4002.110H		◀ ▶		432 x 200 x 18	KABI0358

SERIJA 4, R, P, T (1996 - ...)



OE broj	MEKRA broj	Opis	Položaj	Grejač	Dimenzije (mm)	RAPIDEX broj
1 765 809	56.4000.140H		◀		250 x 190 x 130	KABI0547
1 765 810	56.4001.140H		▶		250 x 190 x 130	KABI0548
1 346 377	15.4001.110H		◀ ▶		432 x 200 x 18	KABI0358
1 767 265	15.4001.740H		◀ ▶		184 x 160 x 20	KABI0549

SERIJA 4 R, P, T (2004 - ...)





OE broj	MEKRA broj	Opis	Položaj	Grejač	Dimenzije (mm)	RAPIDEX broj
1 504 678	59.5520.040H		◀ ▶		319 x 187 x 75	KABI0550

LEGENDA:

	MANUELNO PODEŠAVANJE		STAKLO		GREJAČ	◀	LEVI POLOŽAJ
	ELEKTRIČNO PODEŠAVANJE		PLOKLOPAC KUĆIŠTE	◀ ▶	UNIVERZALAN POLOŽAJ	▶	DESNI POLOŽAJ

CILINDRI ZA DIZANJE KABINE			
Poz.	Model vozila	OE broj	RAPIDEX broj
1.	SERIJA 4	1549738	KABI0268
			
2.	SERIJA P, G, R, T	1549737	KABI0924
			
3.	SERIJA P, G, R, T	1720924	KABI0964
			

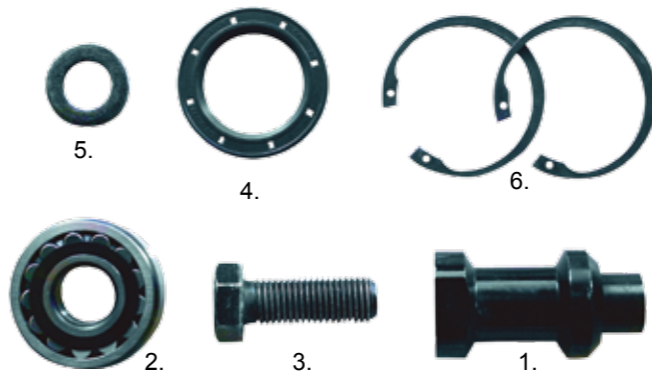
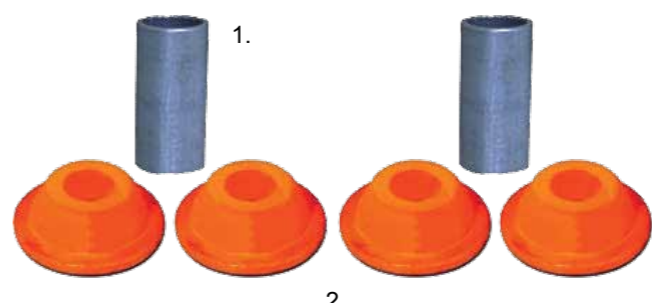
PUMPE ZA DIZANJE KABINE				
Poz.	Slika	Model vozila	OE broj	RAPIDEX broj
1.		SERIJA 4, P, G, R, T	1234778	KABI0567
2.		SERIJA P, G, R, T	1549741	HIDR0004

ELEMENTI ZA OSLANJANJE KABINE			
Poz.	Slika	Model / OE broj	RAPIDEX broj
1.		SERIJA 3, 4	KABI0270
		1 742 999	
2.		SERIJA 3, 4	KABI0590
		1. 1 375 299 x 1 2. 1 324 713 x 1 3. 1 358 632 x 1 4. 1 324 712 x 1 5. 1 386 058 x 1 6. 804831 x 2	
3.		SERIJA 3, 4	KABI0267
		1. 1 343 135 x 2 2. 1 481 245 x 4	
4.		SERIJA 3, 4	KABI0266
		1. 1 377 562 x 1 2. 1 385 170 x 2	

ELEMENTI ZA OSLANJANJE KABINE					
Poz.	Slika	Model vozila	Dimenzije (mm)	OE broj	RAPIDEX broj
1.		SERIJA P, G, R, T	M16 x 20/35 H=67,5	1755638	KABI1430
2.		SERIJA 3, 4	20 x 16 x 40	550285	KABI0591
3.		SERIJA 3, 4	60 x 16 x 80	1 394 544	KABI0592
4.		SERIJA 3, 4	60 x 16 x 80	1 377 562	KABI0593
5.		SERIJA 3, 4	50 x 16,5 x 80	1 105 972	KABI0594
6.		SERIJA 3, 4		329 583	KABI0595
7.		SERIJA 3, 4	71 x 24 x 79,5	1 372 432	KABI0596
8.		SERIJA 3, 4		0 390 359	KABI0597
9.		SERIJA 3, 4		0 389 035	KABI0598
10.		SERIJA 3, 4	75 x 8	1 385 170	KABI0599

ELEMENTI ZA OSLANJANJE KABINE					
Poz.	Slika	Model vozila	Dimenzije (mm)	OE broj	RAPIDEX broj
11.		SERIJA 3, 4	55 x 22 x 44	0 385 266	KABI0600
12.		SERIJA 3, 4	74 x 21 x 10	1 353 965	KABI0601
13.		SERIJA 3, 4	63 x 21 x 20	1 343 134	KABI0602
14.		SERIJA 3, 4	Ø60 x 41 M8 x 1,25	0 384 595	KABI0603
15.		SERIJA 3, 4	Ø55 x 45 M8 x 1,25	1 349 805	KABI0604
16.		SERIJA 3, 4	Ø40 x 32 M8 x 1,25	1 349 810	KABI0605
17.		SERIJA 3, 4	44 x 21 x 28	1 302 008	KABI0606
18.		SERIJA 3, 4	16 x 81	1 744 210	KABI0607
19.		SERIJA 3, 4	16 x 120	1 744 211	KABI0608

UREĐAJI ZA PRANJE VETROBRANSKOG STAKLA

Poz.	Model vozila	Opis	OE broj	RAPIDEX broj
1.	SERIJA 4 CP, CR, CT	METLICA BRISAČA 700 mm	1 431 178	KABI0008
2.	SERIJA 4	MOTOR BRISAČA	1 318 506	KABI0648
3.	SERIJA 4	MOTOR BRISAČA	1 392 755	KABI0888
4.	SERIJA 3	MOTOR BRISAČA	1 323 405	ELEK0107
5.	CP, CR, CT	MOTOR BRISAČA	1 859 562	KABI0650
6.	CP, CR, CT	POLUGA BRISAČA	1 525 890	KABI0629
7.	CP, CR, CT	POLUGA BRISAČA	1 525 888	KABI0630
8.	CP, CR, CT	POLUGA BRISAČA	1 525 889	KABI0631
9.	CP, CR, CT	PUMPICA BRISAČA	1 548 504	KABI0635
10.	CP, CR, CT	RUČICA BRISAČA	1 543 076	KABI0641
11.	CP, CR, CT	RUČICA BRISAČA	1 543 077	KABI0642
12.	CP, CR, CT	RUČICA BRISAČA	1 733 180	KABI0643
13.	CP, CR, CT	RUČICA BRISAČA	1 733 181	KABI0644

MEHANIZAM VRATA

Poz.	Model vozila	Opis	Položaj	OE broj	RAPIDEX broj
1.	CP, CG, CR, CT	BRAVA VRATA	◀	1 789 311	KABI0666
2.	CP, CG, CR, CT	BRAVA VRATA	▶	1 789 312	KABI0667
3.	CP, CG, CR, CT	KVAKA VRATA	◀	1 544 330	KARO0612
4.	CP, CG, CR, CT	KVAKA VRATA	▶	1 544 331	KARO0611
5.	CP, CG, CR, CT	MOTOR PODIZAČA	◀	1 442 292	KABI0702
6.	CP, CG, CR, CT	MOTOR PODIZAČA	▶	1 442 293	KABI0703
7.	CP, CG, CR, CT	PODIZAČ PROZORA ELEKTRONSKI	◀	1 442 294	KABI0682
8.	CP, CG, CR, CT	PODIZAČ PROZORA ELEKTRONSKI	▶	1 442 295	KABI0683
9.	CP, CG, CR, CT	VENTIL GREJANJA	-	1 450 166	KABI0690
10.	CP, CG, CR, CT	VENTIL GREJANJA	-	1 741 027	KABI0691
11.	CP, CG, CR, CT	ULOŽAK KVAKE SA KLJUČEM	◀▶	1 733 441	ELEK1390

7.0 ELEKTRIČNE INSTALACIJE



7.0 ELEKTRIČNE INSTALACIJE

7.1	Farovi	138
7.2	Pokazivači pravca	142
7.3	Stop i gabaritna svetla	143
7.4	Rotacione lampe	147
7.5	Sijalice, osigurači i tahograf listići	150
7.6	Kablovi električne instalacije	155
7.7	Kombinovani prekidači pod volanom	158
7.8	Pribori	159
7.9	Anlaseri i alternatori	160

SERIJA 4 (1996 - ...)

OE broj	OPIS	RAPIDEX broj
1 431 257	▶ H4	RASV1031
1 431 256	◀	RASV1030
1 446 584	▶ STAKLO	RASV0468
1 446 583	◀ STAKLO	RASV0158



1 529 071	▶	RASV0989
1 529 070	◀	RASV0988

SERIJA P, SERIJA R, SERIJA T (2007 - ...)

OE broj	OPIS	RAPIDEX broj
1 760 554	▶ XENON D2R H7	RASV0693
1 760 551	◀	RASV0964
1 549 815	▶ STAKLO	RASV1519
1 549 814	◀ STAKLO	RASV1518

SERIJA P, SERIJA R, SERIJA T (2014 - ...)

OE broj	OPIS	RAPIDEX broj
1 949 908	▶	RASV1520
1 949 906	◀	RASV1521

SERIJA P, SERIJA R, SERIJA T (2014 - ...)

OE broj	OPIS	RAPIDEX broj
2 241 827	▶	RASV1525
2 241 826	◀	RASV1526

SERIJA P, SERIJA R, SERIJA T (2014 - ...)

OE broj	OPIS	RAPIDEX broj
1 949 894	▶ XENON D1R H7	RASV1527
1 949 890	◀	RASV1528

SERIJA P, SERIJA R, SERIJA T (2004 - ...)

OE broj	OPIS	RAPIDEX broj
1 446 356	▶	RASV0998
1 446 355	◀	RASV0997



1 446 354	▶	RASV0996
1 446 353	◀	RASV0995

UNIVERZALNI FAR

KBP	OPIS	RAPIDEX broj
1G3 005 760-021	 Ø152 mm	RASV0718

UNIVERZALNI FAR

KBP	OPIS	RAPIDEX broj
1GA 005 060-001	 153 x 93 mm	RASV0230

UNIVERZALNI FAR

KBP	OPIS	RAPIDEX broj
1GA 006 991-021	 158 x 105 mm	RASV0719

UNIVERZALNI FAR

KBP	OPIS	RAPIDEX broj
1GA 006 991-081 44.120.000	 112 x 102mm	RASV0168

UNIVERZALNI FAR

KBP	OPIS	RAPIDEX broj
44.040.500	 170 x 100 mm	RASV0167

LED UNIVERZALNI FAR

KBP	OPIS	RAPIDEX broj
91017420	 LED 9-30 V, 1200 LUMEN 105 x 124	RASV0546

LED UNIVERZALNI FAR

KBP	OPIS	RAPIDEX broj
098174090	 LED 9-30 V, 1200 LUMEN 140 x 114	RASV1342

SERIJA 4 (1996 - ...)



OE broj	OPIS	RAPIDEX broj
1 387 155	▶ ↔	RASV0987
1 385 410	◀ ↔	RASV0986

SERIJA P, R, T (2004 - ...)



OE broj	OPIS	RAPIDEX broj
1 747 981	▶ ↔	RASV0157
	◀ ↔	

SERIJA P, R, T (2014 - ...)



OE broj	OPIS	RAPIDEX broj
2 241 544	▶ ↔	RASV1523
	◀ ↔	

SERIJA P, R, T (2014 - ...)



OE broj	OPIS	RAPIDEX broj
1 949 898	▶ ↔	RASV1524
	◀ ↔	

SERIJA R, P (2007 - ...)



OE broj	OPIS	RAPIDEX broj
1 770 301	▶ ↔	RASV0747
	◀ ↔	

SERIJA 3 (1988 - 1995)



OE broj	OPIS	RAPIDEX broj
1 365 964	▶	RASV0478
1 365 963	◀ 468 x 134 mm	RASV0477
1 350 343	▶ STAKLO	RASV0306
	◀ STAKLO	

SERIJA 4 (1996 - ...), SERIJA R (2004 - ...)

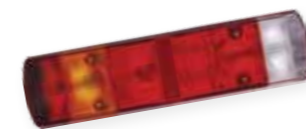

OE broj	OPIS	RAPIDEX broj
1 371 975	▶	RASV0448
1 371 974	◀ 510 x 136 mm	RASV0446
1 498 103	▶	RASV0992
1 498 102	◀ 510 x 136 mm	RASV0991
1 380 819	▶ STAKLO	RASV1046
	◀ STAKLO	



1 756 751	▶	RASV0295
1 756 754	◀ 400 x 160 mm	RASV0296
1 791 369	▶ SA RIKVERC ALARMOM	RASV0760
1 784 670	▶ STAKLO	RASV0305
1 784 669	◀ STAKLO	RASV0297

RIKVERC ALARMI

Poz.	Slika	Naziv / Opis	RAPIDEX broj
1.		RIKVERC ALARM 12/24 V, 97 dB	OSTA0370
2.		RIKVERC ALARM 12/24 V, 97 dB	OSTA0247

SERIJA 4, P, R, T

OE broj	OPIS	RAPIDEX broj
1 326 935	 24V T5W-Ba15s	RASV0847

SERIJA P, G, R, T (2004 - ...)

OE broj	OPIS	RAPIDEX broj
1 798 980	 24V LED	RASV1238

SERIJA 4

OE broj	OPIS	RAPIDEX broj
1 471 599	 LED	RASV0990

SERIJA 4, P, G, R, T (2004 - ...)

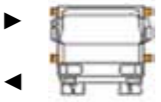
OE broj	OPIS	RAPIDEX broj
1 379 371	 24V W5W-W2,1X9,5D	RASV0848

SERIJA 4, P, G, R, T (2004 - ...)

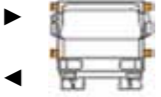
OE broj	OPIS	RAPIDEX broj
1 446 359	 LED	RASV0849

SVETLA REGISTRAR TABLICE

KBP	OPIS	RAPIDEX broj
2KA 003 389-061	  12/24V R10W-Ba15s	RASV0396
26-3010-004	  12/24V C5W-SV8,5	RASV0075
26-3000-004	  12/24V C5W-SV8,5	RASV0105
-	  LED	RASV0521
-	  LED	RASV1440



KATADIOPTERI

KBP	OPIS		RAPIDEX broj
8RA 002 014-041	BELI	Ø 60 mm	RASV0861
8RA 002 014-051	ŽUTI		RASV0459
8RA 002 014-031	CRVENI		RASV0460
8RA 003 326-021	BELI	94 x 44 mm	RASV0458
8RA 003 326-011	ŽUTI		RASV0457
8RA 003 326-001	CRVENI		RASV0410
01.090.7520.05			RASV0222



KL 7000 F



KBP	OPIS		RAPIDEX broj
2RL 008 061-101	12V		RASV0862
2RL 008 061-111	24V		RASV0863
9EL 862 141-001	ŽUTO STAKLO		RASV0864
9EL 862 140-001	PLAVO STAKLO		RASV0865

KL 7000 M



KBP	OPIS		RAPIDEX broj
2RL 008 062-101	12/24V		RASV0866
2RL 008 062-111	24/12V		RASV0867
9EL 862 141-001	ŽUTO STAKLO		RASV0864
9EL 862 140-001	PLAVO STAKLO		RASV0865

KL 7000 M



KBP	OPIS		RAPIDEX broj
2RL 008 062-001	12/24V		RASV0868
2RL 008 062-011	24/12V		RASV0869
9EL 862 141-001	ŽUTO STAKLO		RASV0864
9EL 862 140-001	PLAVO STAKLO		RASV0865

KL 7000 R

KBP	OPIS	RAPIDEX broj
2RL 008 060-101	12/24V	 H1 RASV0870
2RL 008 060-111	24/12V	
9EL 862 141-001	ŽUTO STAKLO	RASV0864
9EL 862 140-001	PLAVO STAKLO	RASV0865

JUNIOR PLUS F

KBP	OPIS	RAPIDEX broj
2RL 008 965-001	12V	 H1 RASV0467
2RL 008 965-011	24V	
9EL 863 100-001	ŽUTO STAKLO	RASV0873

JUNIOR F

KBP	OPIS	RAPIDEX broj
2RL 007 550-001	12V	 H1 RASV0533
2RL 007 550-011	24V	
9EL 860 627-001	ŽUTO STAKLO	RASV0505
9EL 860 628-021	PLAVO STAKLO	RASV0874

JUNIOR M

KBP	OPIS	RAPIDEX broj
2RL 007 552-001	12V	 H1 RASV0560
2RL 007 552-011	24V	
9EL 860 627-001	ŽUTO STAKLO	RASV0505
9EL 860 628-021	PLAVO STAKLO	RASV0874

JUNIOR R

KBP	OPIS	RAPIDEX broj
2RL 007 551-001	12V	 H1 RASV0055
2RL 007 551-011	24V	
9EL 860 627-001	ŽUTO STAKLO	RASV0505
9EL 860 628-021	PLAVO STAKLO	RASV0874

H1 - P14,5s

OPIS	RAPIDEX broj
12V H1-55W	RASV1089
24V H1-70W	RASV1088

H2 - H511

OPIS	RAPIDEX broj
12V H2-55W	RASV0880
24V H2-70W	RASV0881

H3 - PK22s

OPIS	RAPIDEX broj
12V H3-55W	RASV1105
24V H3-70W	ELEK0294

H4 - P43t

OPIS	RAPIDEX broj
12V H4-60/55W	RASV1085
24V H4-75/70W	ELEK0295

H7 - Px26d

OPIS	RAPIDEX broj
12V H7-55W	RASV1084
24V H7-70W	RASV1078

H8 - PGJ19-1

OPIS	RAPIDEX broj
12V H8-35W	RASV0882

H9 - PGJ19-5

OPIS	RAPIDEX broj
12V H9-55W	RASV0877

H10 - PY20d

OPIS	RAPIDEX broj
12V H10-42W	RASV0883

H11 - PGJ19-2

OPIS	RAPIDEX broj
12V H11-55W	RASV0878
24V H11-70W	RASV0879

H21W - BAY9s

OPIS	RAPIDEX broj
12V H21W	RASV0884
24V H21W	RASV1079

D2R - P32d3

OPIS	RAPIDEX broj
D2R-35W	RASV0885

D2S - P32d2

OPIS	RAPIDEX broj
D2S-35W	RASV0886

R2 - P45t

OPIS	RAPIDEX broj
12V R2-45/40W	RASV0550
24V R2-55/50W	RASV0571

P21W - BA15s

OPIS	RAPIDEX broj
12V P21W	RASV1083
24V P21W	ELEK0293

PY21W - BAU15s

OPIS	RAPIDEX broj
12V PY21W	RASV0562
24V PY21W	RASV0499

P21/5W - BAY15d

OPIS	RAPIDEX broj
12V P21/5W	RASV0535
24V P21/5W	RASV1076

R5W - BA15s

OPIS	RAPIDEX broj
12V R5W	RASV1082
24V R5W	RASV1072

R10W - BA15s

OPIS	RAPIDEX broj
12V R10W	RASV0490
24V R10W	RASV1075

C5W - SV8,5

OPIS	RAPIDEX broj
12V C5W	RASV0887
24V C5W	RASV1074

C10W - SV8,5

OPIS	RAPIDEX broj
12V C10W	RASV0888
24V C10W	RASV0315

T3W - BA9s

OPIS	RAPIDEX broj
12V T3W	RASV0502
24V T3W	RASV0501

T4W - BA9s

OPIS	RAPIDEX broj
12V T4W	ELEK0291
24V T4W	RASV1071

W3W - W2,1x9,5d

OPIS	RAPIDEX broj
12V W3W	RASV0564
24V W3W	RASV0569

W5W - W2,1x9,5d

OPIS	RAPIDEX broj
12V W5W	RASV0484
24V W5W	RASV1073

W1,2W - W2x4,6d

OPIS	RAPIDEX broj
12V W1,2W	RASV0563
24V W1,2W	RASV1069

W1,2W - B8,3d

OPIS	RAPIDEX broj
12V W1,2W	RASV0893
24V W1,2W	RASV1070

GARNITURA SIJALICA H7

OPIS	RAPIDEX broj
12V H7	RASV1180
24V H7	RASV1081

GARNITURA SIJALICA H4

OPIS	RAPIDEX broj
12V H4	RASV1086
24V H4	RASV1080

GARNITURA SIJALICA H7

OPIS	RAPIDEX broj
2 x 24V H7	RASV0892

GARNITURA SIJALICA H4

OPIS	RAPIDEX broj
2 x 24V H4	RASV0895

OSIGURAČI UBODNI

Slika	Poz.	Opis	KBP	RAPIDEX broj
	1.	5A OKER	8JS 711 684-002	ELEK0684
	2.	7,5A BRAON	8JS 711 685-002	ELEK0258
	3.	10A CRVENI	8JS 711 686-002	RASV0568
	4.	15A PLAVI	8JS 711 687-002	RASV0567
	5.	20A ŽUTI	8JS 711 688-002	ELEK0257
	6.	25A BELI	8JS 711 689-002	ELEK0575
	7.	30A ZELENI	8JS 711 690-002	RASV0539
	8.	40A NARANDŽASTI	8JS 711 683-031	ELEK0769

OSIGURAČI UBODNI - MINI

Slika	Poz.	Opis	KBP	RAPIDEX broj
	1.	5A	8JS 728 596-131	RASV0183
	2.	7,5A	8JS 728 596-111	RASV0184
	3.	10A	8JS 728 596-141	RASV0185
	4.	15A	8JS 728 596-151	RASV0186
	5.	20A	8JS 728 596-161	RASV0187
	6.	25A	8JS 728 596-091	RASV0188
	7.	30A	8JS 728 596-171	RASV0189

OSIGURAČI UBODNI - MAXI

Slika	Poz.	Opis	KBP	RAPIDEX broj
	1.	20A	8JS 728 595-051	RASV0920
	2.	30A	8JS 728 595-141	RASV0921
	3.	40A	8JS 728 595-151	RASV0922
	4.	50A	8JS 728 595-161	RASV0923
	5.	60A	8JS 728 595-171	RASV0924
	6.	70A	8JS 728 595-101	RASV0925
	7.	80A	8JS 728 595-111	RASV0927

OSIGURAČI - MIDI

Slika	Poz.	Opis	KBP	RAPIDEX broj
	1.	30A	8JS 742 901-061	RASV0928
	2.	50A	8JS 742 901-011	RASV0929
	3.	150A	8JS 742 901-081	RASV0052

OSIGURAČI - MEGA

Slika	Poz.	Opis	KBP	RAPIDEX broj
	1.	125A	8JS 742 902-011	RASV0930
	2.	150A	8JS 742 902-021	RASV0931
	3.	200A	8JS 742 902-041	RASV0932
	4.	250A	8JS 742 902-051	RASV0933
	5.	300A	8JS 742 902-071	RASV0934

TAHOGRAF LISTIĆI

Slika	Poz.	Opis	RAPIDEX broj
	1.	100-24 EC4K	OPRE0210
	2.	100-3300-24 EC4	OPRE0220
	3.	125-24 EC4K	OPRE0224
	4.	125-3300-24 EC4KA	OPRE0122
	5.	140-24 EC4K	OPRE0216
	6.	SERTIFIKAT-VIKEND	OPRE0105
	7.	ROLNICA ZA DIGITALNI TAHOGRAF	ELEK1112



SPIRALNI KABLOVI

Slika	Poz.	Opis	KBP	RAPIDEX broj
	1.	7 - ŽILNI	611 110	ELEK0609
	2.	ISO 1724 7 - lni	8KA 004 797-021	ELEK0770
	3.	ISO 1185 7 - lni	8KA 004 797-041	ELEK0287
	4.	ISO 3731 7 - lni	8KA 004 797-051	ELEK0370
	5.	ISO 7638 ABS/EBS	446 008 700 0	ELEK1368
	6.	ISO 12098 15 - lni	446 008 710 0	ELEK1122
	7.	15/2 x 7 - lni	8JA 005 952-041	ELEK0450

ADAPTER				
Slika	Poz.	Opis	KBP	RAPIDEX broj
	1.	15/2 x 7 - lin	8JA 005 952-061	ELEK0247

UTIKAČI				
Slika	Poz.	Opis	KBP	RAPIDEX broj
	1.	ISO 1724 7 - Ini 12V	8JA 001 930-003	ELEK0607
	2.	ISO 1185 7 - Ini	8JA 008 831-001	RASV0541
	3.	ISO 3731 7 - Ini	8JA 008 832-011	ELEK0491
	4.	ISO 7638 ABS/EBS	8JB 007 645-031	ELEK0470
	5.	ISO 12098 15 - Ini	8JA 007 241-031	ELEK0250

UTIČNICE				
Slika	Poz.	Opis	KBP	RAPIDEX broj
	1.	ISO 1724 7 - Ini 12V	8JB 001 943-003	ELEK0606
	2.	ISO 1185 7 - Ini	8JB 003 833-001	RASV0513
	3.	ISO 3731 7 - Ini	8JB 003 834-001	RASV0452
	4.	ISO 7638 ABS/EBS	8JB 007 645-031	ELEK0402
	5.	ISO 12098 15 - Ini	8JB 007 242-011	ELEK0249

KOMBINOVANI PREKIDAČI POD VOLANOM				
Slika	Poz.	Model vozila	OE broj	RAPIDEX broj
	1.	94, 114, 124, 144	1 402 449	ELEK0799
	2.	113, 143	360248	ELEK0008
	3.	94, 114, 124, 144	1 373 190	ELEK0006
	4.	114, 124, 144	1 4024 48	ELEK0285

PRIBORI		
Slika	Opis	RAPIDEX broj
	Kablovi za startovanje 25 mm ² x 3,5 m	ELEK0554
	Kablovi za startovanje 35 mm ² x 4,5 m	ELEK0703
	Kablovi za startovanje 50 mm ² x 7 m	ELEK0704
	Kontakt klešta 25 - 50 mm ²	ELEK0705
	Klemna +	ELEK0640
	Klemna -	ELEK0600
	Merač kiseline	ELEK0706

SERIJA P, G, R, T				
Slika	Opis	KBP	OE broj	RAPIDEX broj
	24 V 5,5 kW 12 Z	0 001 241 001	1 447 911	ELEK0773

SERIJA 3, 4				
Slika	Opis	KBP	OE broj	RAPIDEX broj
	24 V 6,7 kW 11 Z	0 001 371 004	1 332 903	ELEK0776

SERIJA 3, 4				
Slika	Opis	KBP	OE broj	RAPIDEX broj
	24 V 6,7 kW 11 Z	0 001 371 006	1 357 709	ELEK0777

SERIJA 3, 4				
Slika	Opis	KBP	OE broj	RAPIDEX broj
	28V 65A	0 120 468 131	1 394 969	ELEK0709

SERIJA P, G, R, T				
Slika	Opis	KBP	OE broj	RAPIDEX broj
	28V 100A PK8 Ø72 mm W 15 DFM L S	0 124 655 007	1 475 569	ELEK0719



8.0 PRIBORI



8.0 PRIBORI

8.1	Obeležavajuće table i pribori A.D.R.	164
8.2	Oprema	179
8.3	Pribor za osiguravanje tereta	182
8.4	Lanci za sneg	184
8.5	Vučne kuke	186
8.6	Grejanje kabine	189

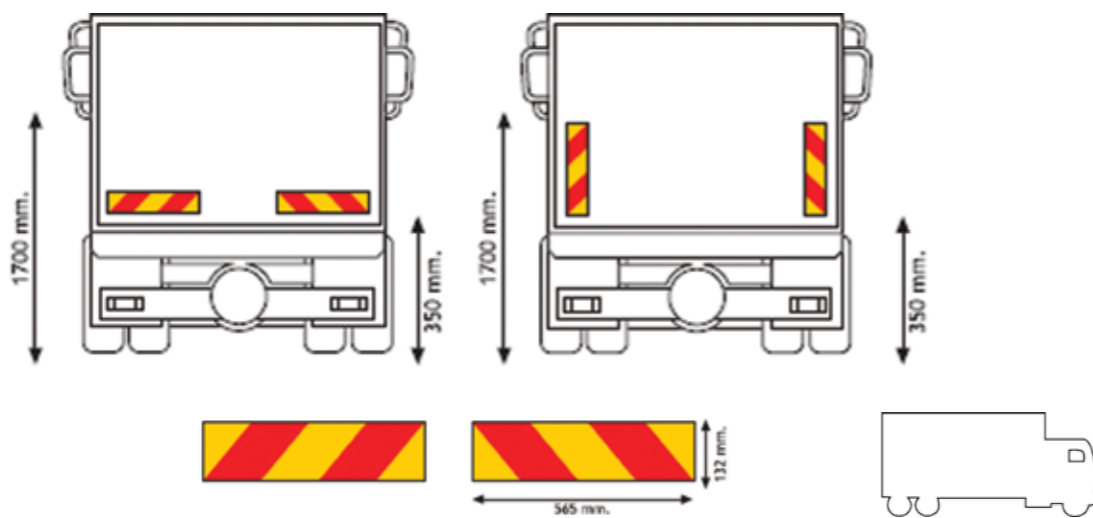
**REFLEKTUJUĆE I FLUOROSCENTNE TABLE ZA KAMIONE
SAGLASNO REGULATIVI ECE 70**

Poz.	Dimenzije (mm)	Opis	Jedinica mere	RAPIDEX broj
1.	565 x 132	Aluminijum	PAR	OPRE0097

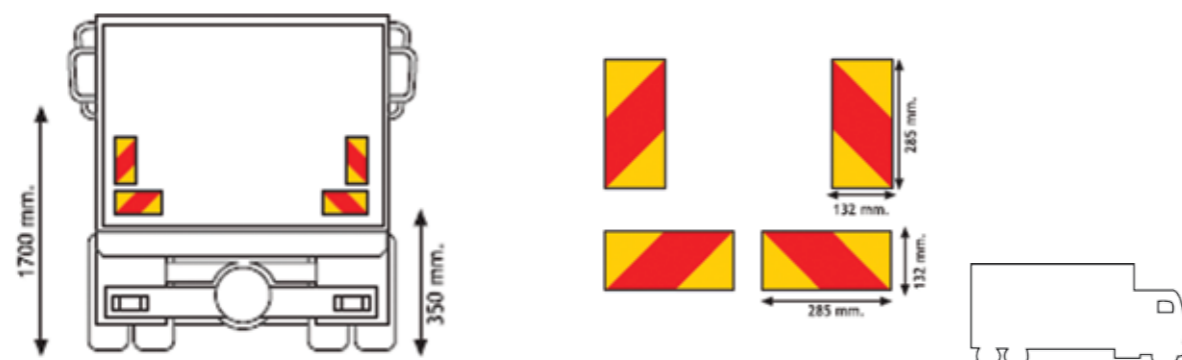

Poz.	Dimenzije (mm)	Opis	Jedinica mere	RAPIDEX broj
2.	285 x 132	Aluminijum	PAR	OPRE0260

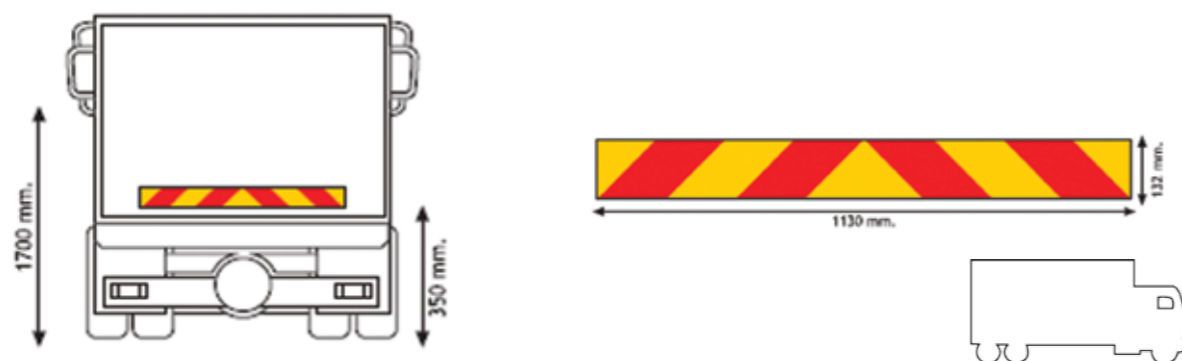

Poz.	Dimenzije (mm)	Opis	Jedinica mere	RAPIDEX broj
3.	1130 x 196	Aluminijum	KOM	OPRE0261

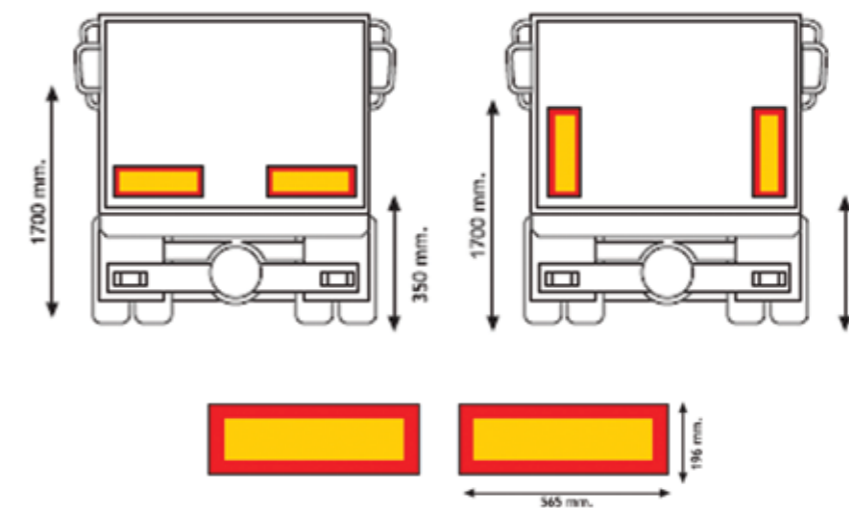
**REFLEKTUJUĆE I FLUOROSCENTNE TABLE ZA KAMIONE
SAGLASNO REGULATIVI ECE 70**

Poz.	Dimenzije (mm)	Opis	Jedinica mere	RAPIDEX broj
1.	565 x 196	Aluminijum	PAR	OPRE0157

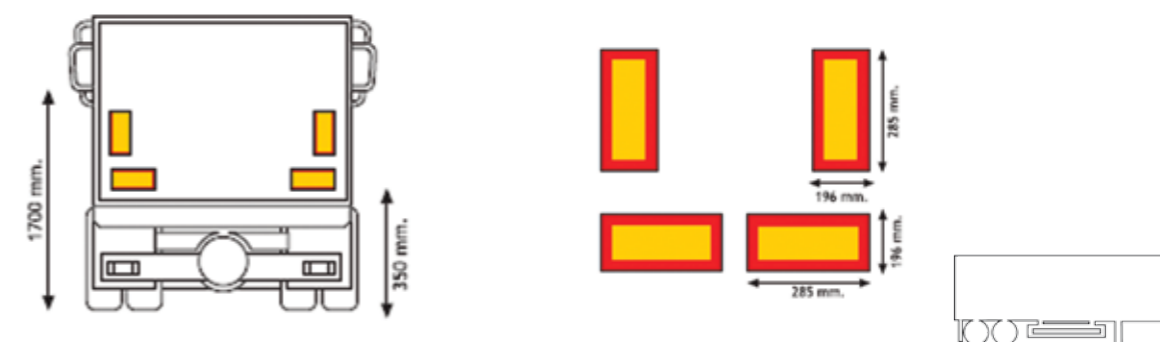

Poz.	Dimenzije (mm)	Opis	Jedinica mere	RAPIDEX broj
2.	285 x 196	Aluminijum	PAR	OPRE0262

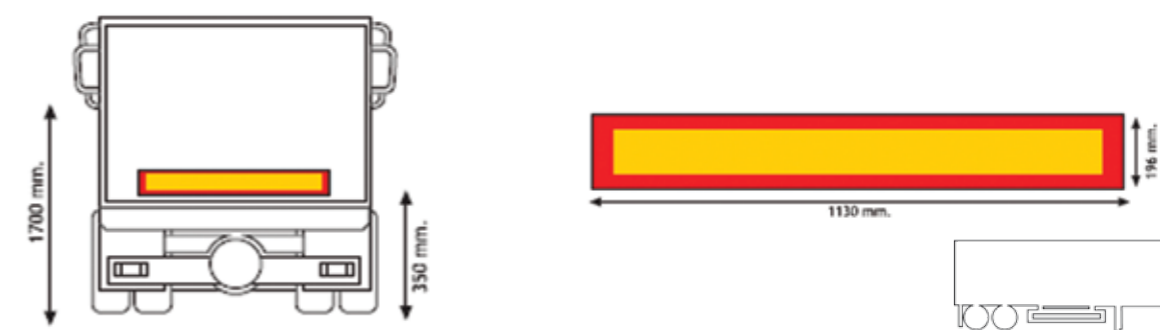

Poz.	Dimenzije (mm)	Opis	Jedinica mere	RAPIDEX broj
3.	1130 x 196	Aluminijum	KOM	OPRE0090

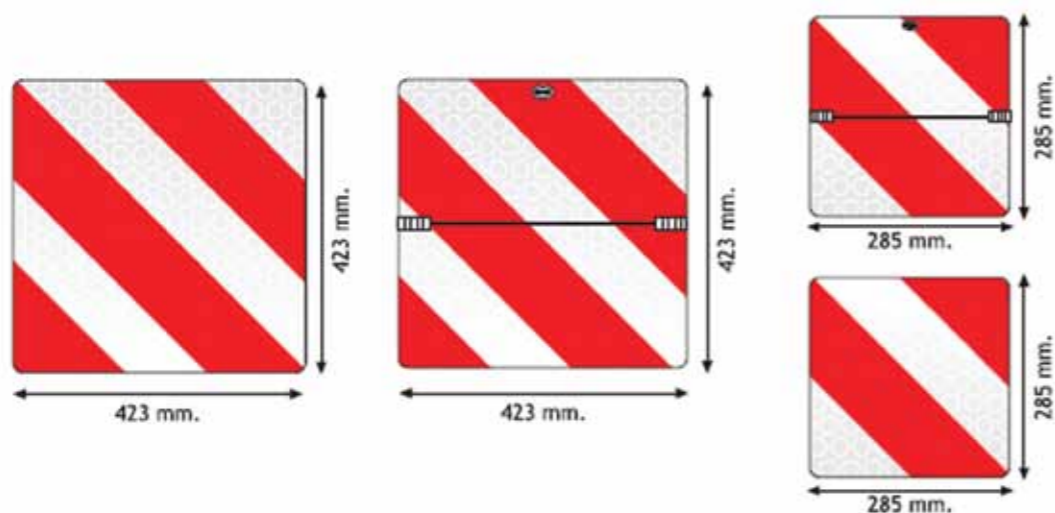
**REFLEKTUJUĆE TABLE ZA PREVOZ TERETA
VAN DOZVOLJENIH GABARITA**

Poz.	Dimenzije (mm)	Opis	Jedinica mere	RAPIDEX broj
1.	423 x 423	Aluminijum / Panel	kom	OPRE0142
2.	423 x 423	Aluminijum / Preklopiva	kom	OPRE0263
3.	285 x 285	Aluminijum / Preklopiva	kom	OPRE0265
4.	285 x 285	Aluminijum / Panel	kom	OPRE0264

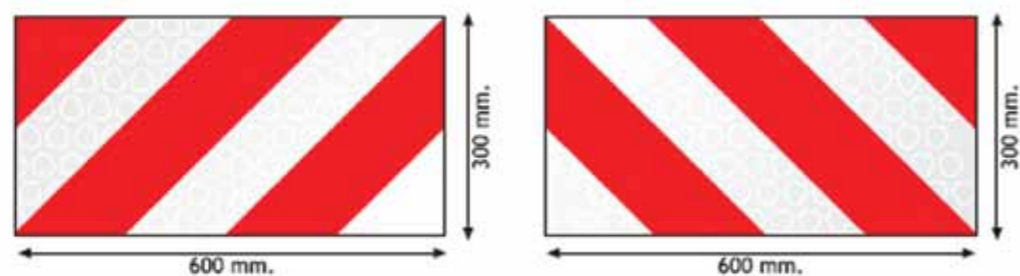

Poz.	Dimenzije (mm)	Opis	Jedinica mere	RAPIDEX broj
5.	600 x 300	Aluminijum / Panel	set	OPRE0266

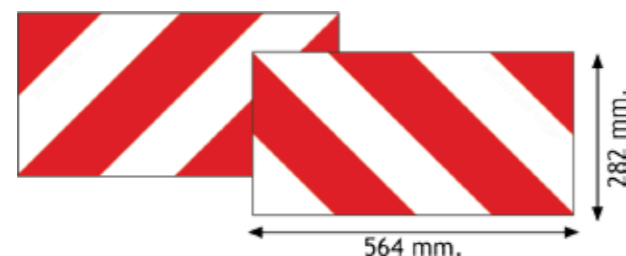

Poz.	Dimenzije (mm)	Opis	Jedinica mere	RAPIDEX broj
6.	564 x 282	Aluminijum / Panel	set	OPRE0267

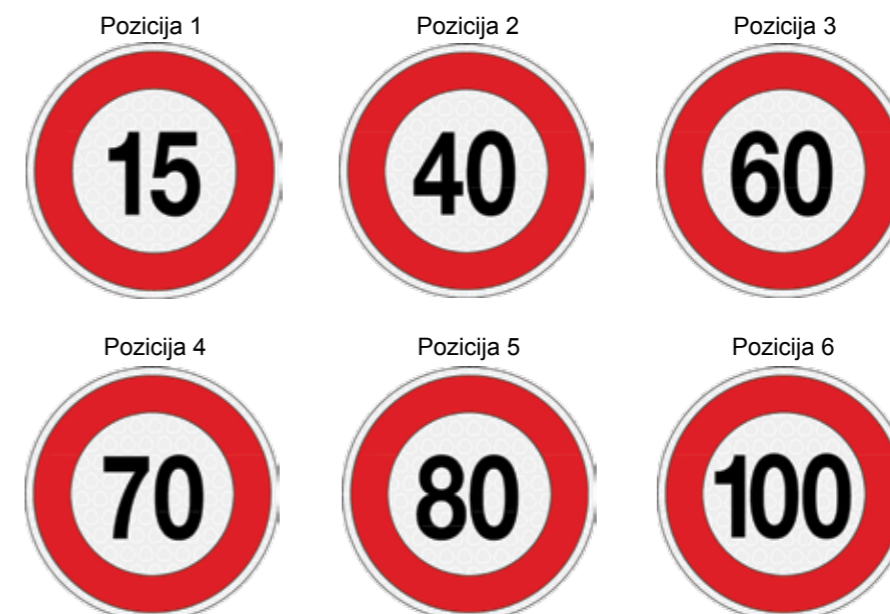
REFLEKTUJUĆE TABLE OGRANIČENJA BRZINE

Poz.	Dimenzije (mm)	Opis	RAPIDEX broj
1.	Ø 200	Nalepnica	OPRE0268
		Aluminijum	OPRE0269
2.	Ø 200	Nalepnica	OPRE0270
		Aluminijum	OPRE0271
3.	Ø 200	Nalepnica	OPRE0272
		Aluminijum	OPRE0273
4.	Ø 200	Nalepnica	OPRE0274
		Aluminijum	OPRE0275
5.	Ø 200	Nalepnica	OPRE0276
		Aluminijum	OPRE0277
6.	Ø 200	Nalepnica	OPRE0278
		Aluminijum	OPRE0279

OZNAČAVAJUĆE TABLE ZA PREVOZ DECE

Poz.	Dimenzije (mm)	Opis	RAPIDEX broj
1.	400 x 400	Aluminijum	OPRE0280
2.	400 x 400	Aluminijum / Preklopiva - Horizontalno	OPRE0089
3.	400 x 400	Nalepnica	OPRE0282

IDENTIFIKACIONE OZNAKE VOZILA

Poz.	Dimenzije (mm)	Opis	RAPIDEX broj
1.	Ø 200	Aluminijum	OPRE0283
2.	Ø 200	Aluminijum	OPRE0284
3.	Ø 200	Aluminijum	OPRE0285
4.	Ø 200	Aluminijum	OPRE0286
5.	Ø 200	Aluminijum	OPRE0055
6.	Ø 200	Aluminijum	OPRE0056
7.	Ø 200	Aluminijum	OPRE0057



Poz.	Dimenzije (mm)	Opis	RAPIDEX broj
1.	Ø 200	Aluminijum	OPRE0287
2.	Ø 200	Aluminijum	OPRE0288
3.	Ø 200	Aluminijum	OPRE0289



Poz.	Dimenzije (mm)	Opis	RAPIDEX broj
1.	400 x 250	Aluminijum	OPRE0290
2.	400 x 250	Aluminijum / Preklopiva - Horizontalno	OPRE0154
3.	400 x 250	Aluminijum / Preklopiva - Vertikalno	OPRE0291

UPOZORAVAJUĆE TABLE HIDRAULIČNIH ZADNJIH VRATA

Poz.	Opis	RAPIDEX broj
1.	Aluminijumska tabla / desna strana	OPRE0292
2.	Aluminijumska tabla / leva strana	OPRE0293
3.	Aluminijumska tabla sa nosačem / desna strana	OPRE0294
4.	Aluminijumska tabla sa nosačem / leva strana	OPRE0295
5.	Aluminijumske table sa nosačima / desna i leva strana - set	OPRE0296

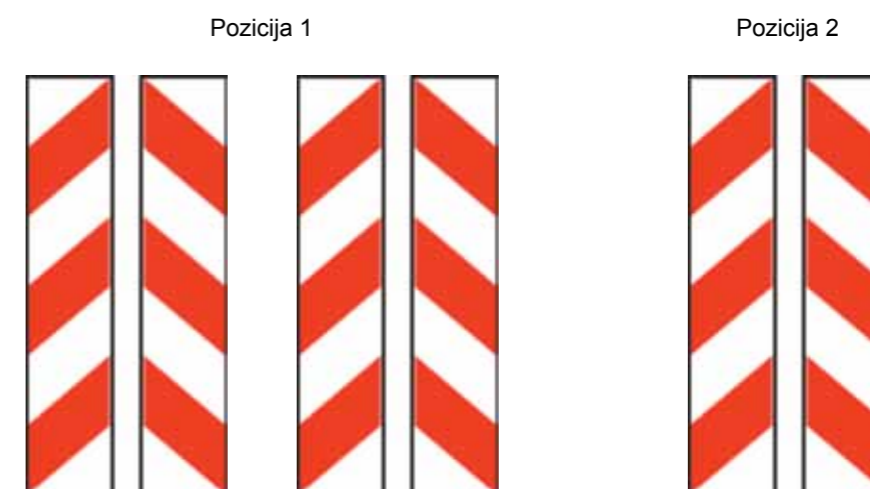
**IDENTIFIKACIONE TABLE ZA VOZILA I KONTEJNERE
SAGLASNO REGULATIVI DIN 67520**

Poz.	Dimenzije (mm)	Opis	RAPIDEX broj
1.	141 x 705	Aluminijum / SET (4 desne + 4 leve table)	OPRE0297
2.	141 x 705	Aluminijum / SET (1 desne + 1 leve table)	OPRE0298

REFLEKTUJUĆE TRAKE ZA VOZILA
SAGLASNO REGULATIVI EEC U.N.104

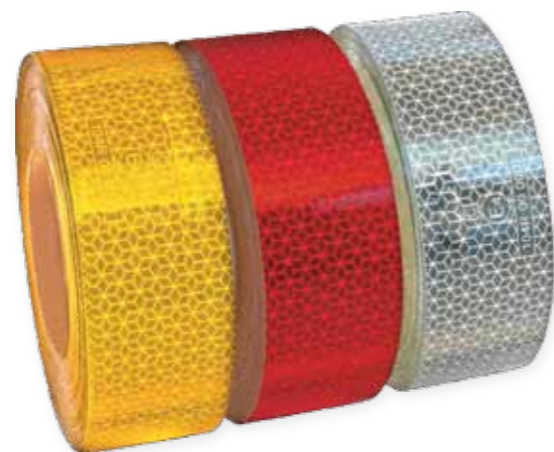

Poz.	Opis	RAPIDEX broj
1.	Reflektujuća traka žute boje 50 mm x 50 m	OPRE0299
2.	Reflektujuća traka crvene boje 50 mm x 50 m	OPRE0300
3.	Reflektujuća traka bele boje 50 mm x 50 m	OPRE0301



Poz.	Opis	RAPIDEX broj
1.	Reflektujuća traka žute boje 50 mm x 50 m	OPRE0815
2.	Reflektujuća traka crvene boje 50 mm x 50 m	OPRE0817
3.	Reflektujuća traka bele boje 50 mm x 50 m	OPRE0816

REFLEKTUJUĆE TRAKE ZA VOZILA
SAGLASNO REGULATIVI EEC U.N.104

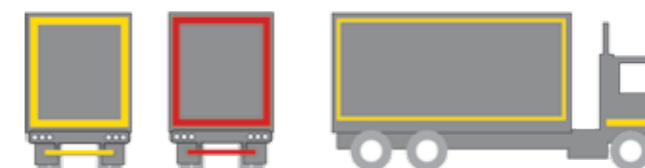
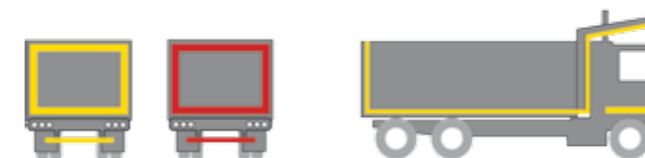
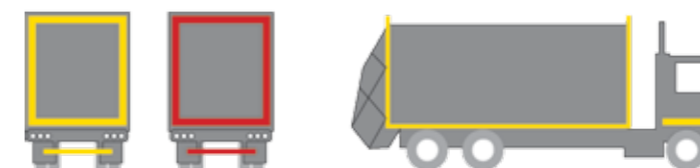
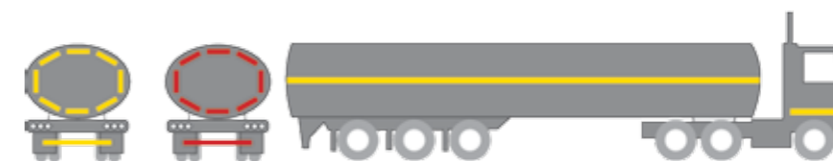

TABLE A.D.R.



Poz.	Dimenzije (mm)	Opis	RAPIDEX broj
1.	400 x 300	Aluminijum	OPRE0153
2.	400 x 300	Aluminijum / Preklopiva - Vertikalno	OPRE0152
3.	400 x 300	Aluminijum / Preklopiva - Horizontalno	OPRE0302



Poz.	Dimenzije (mm)	Opis	RAPIDEX broj
1.	400 x 300	30 - 1202 - Dizel	OPRE0035
2.	400 x 300	33 - 1203 - Benzin	OPRE0036
3.	400 x 300	30 - 1223 - Kerozin	OPRE0037
4.	400 x 300	23 - 1965 - LPG	OPRE0038
5.	400 x 300	23 - 1978 - Propan	OPRE0039
6.	400 x 300	23 - 1971 - Prirodni gas	OPRE0040
7.	400 x 300	23 - 1951 - Tečni argon	OPRE0041
8.	400 x 300	22 - 1977 - Tečni azot	OPRE0042
9.	400 x 300	22 - 2187 - Tečni CO ₂	OPRE0043
10.	400 x 300	223 - 1966 - Tečni vodonik	OPRE0044
11.	400 x 300	225 - 1073 - Tečni kiseonik	OPRE0045
12.	400 x 300	263 - 1040 - Etilenoksid	OPRE0046
13.	400 x 300	23 - 1011 - Butan	OPRE0047
14.	400 x 300	223 - 1038 - Tečni etilen	OPRE0048
15.	400 x 300	223 - 1972 - Tečni prirodni gas	OPRE0049
16.	400 x 300	30 - 1202 - Dizel / Preklopiva - Horizontalno	OPRE0052
17.	400 x 300	33 - 1203 - Benzin / Preklopiva - Horizontalno	OPRE0053
18.	400 x 300	30 - 1202 - Dizel / Preklopiva - Vertikalno	OPRE0303
19.	400 x 300	33 - 1203 - Benzin / Preklopiva - Vertikalno	OPRE0304

TABLE A.D.R.

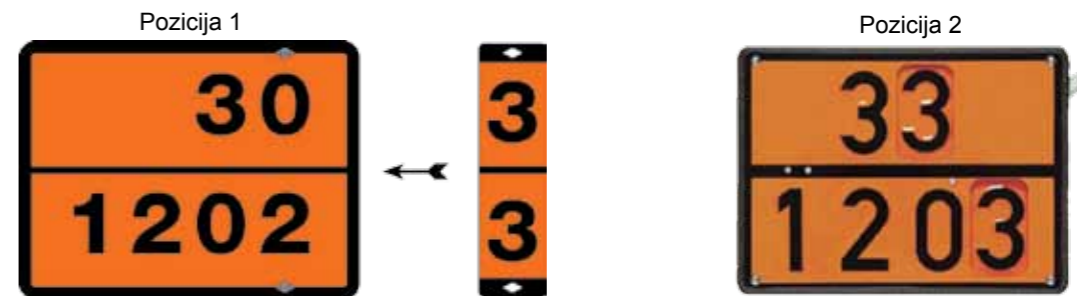

Poz.	Dimenzije (mm)	Opis	RAPIDEX broj
1.	400 x 300	Izmenljiva tabla za dizel i benzin	OPRE0305
2.	400 x 300	Izmenljiva tabla sa ručicom za dizel i benzin	OPRE0054

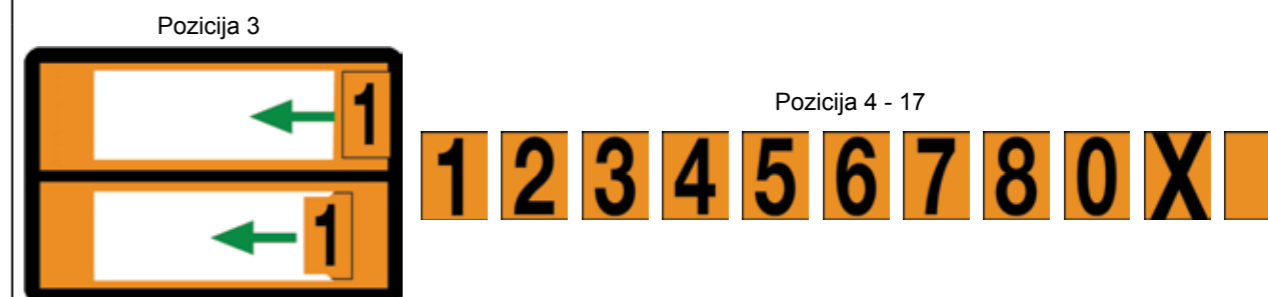

Poz.	Dimenzije (mm)	Opis	RAPIDEX broj
3.	400 x 300	Tabla(nosač) A.D.R. za različite trasporte	OPRE0034
4.	70 x 118	Set od 10 simbola za tablu A.D.R.: 0 - 2 kom.; 1 - 1 kom.; 2 - 2 kom.; 3 - 3 kom.; Prazno polje - 2 kom.	OPRE0050
5.	70 x 118	Set od 12 simbola za tablu A.D.R.: 1 - 1 kom.; 2 - 1 kom.; 3 - 2 kom.; 5 - 1 kom.; 6 - 3 kom.; 7 - 1 kom.; 8 - 1 kom.; Prazno polje - 2 komada	OPRE0051
6.	70 x 118	Set od 33 simbola za tablu A.D.R.: 0 - 3 kom.; 1 - 3 kom.; 2 - 3 kom.; 3 - 4 kom.; 4 - 2 kom.; 5 - 3 kom.; 6 - 5 kom.; 7 - 2 kom.; 8 - 3 kom.; X - 2 kom.; Prazno polje - 3 komada	OPRE0306
7.	70 x 118	Broj 1 za tablu A.D.R.	OPRE0307
8.	70 x 118	Broj 2 za tablu A.D.R.	OPRE0308
9.	70 x 118	Broj 3 za tablu A.D.R.	OPRE0309
10.	70 x 118	Broj 4 za tablu A.D.R.	OPRE0310
11.	70 x 118	Broj 5 za tablu A.D.R.	OPRE0311
12.	70 x 118	Broj 6 za tablu A.D.R.	OPRE0312
13.	70 x 118	Broj 7 za tablu A.D.R.	OPRE0313
14.	70 x 118	Broj 8 za tablu A.D.R.	OPRE0314
15.	70 x 118	Broj 0 za tablu A.D.R.	OPRE0315
16.	70 x 118	Simbol X za tablu A.D.R.	OPRE0316
17.	70 x 118	Prazno polje za tablu A.D.R.	OPRE0317

TABLE ZA OZNAČAVANJE OPASNIH MATERIJIA 300 x 300 mm

	Klasa 1.1, 1.2, 1.3 RAPIDEX broj: OPRE0318		Klasa 1.4 RAPIDEX broj: OPRE0320		Klasa 1.5 RAPIDEX broj: OPRE0319
	Klasa 1.6 RAPIDEX broj: OPRE0321		Klasa 2 RAPIDEX broj: OPRE0322		Klasa 2 RAPIDEX broj: OPRE0323
	Klasa 2 RAPIDEX broj: OPRE0324		Klasa 3 RAPIDEX broj: OPRE0340		Klasa 4.1 RAPIDEX broj: OPRE0325
	Klasa 4.2 RAPIDEX broj: OPRE0326		Klasa 4.3 RAPIDEX broj: OPRE0327		Klasa 5 RAPIDEX broj: OPRE0328
	Klasa 5.1 RAPIDEX broj: OPRE0329		Klasa 5.2 RAPIDEX broj: OPRE0330		Klasa 6.1 RAPIDEX broj: OPRE0331
	Klasa 6.2 RAPIDEX broj: OPRE0332		Klasa 7/A RAPIDEX broj: OPRE0333		Klasa 7/B RAPIDEX broj: OPRE0334
	Klasa 7/C RAPIDEX broj: OPRE0335		Klasa 7 RAPIDEX broj: OPRE0336		Klasa 8 RAPIDEX broj: OPRE0337
	Klasa 9 RAPIDEX broj: OPRE0338		Klasa 9 RAPIDEX broj: OPRE0339		

TABLE ZA OZNAČAVANJE OPASNIH MATERIJIA

KLASA	OPASNE MATERIJIE
1	Eksplozivne materije i predmeti punjeni eksplozivnim materijama
2	Zbijeni gasovi, gasovi pretvoreni u tečnost i gasovi rastvoreni pod pritiskom
3	Zapaljive tečnosti
4.1	Zapaljive čvrste materije
4.2	Materije sklone samopaljenju
4.3	Materije koje u dodiru sa vodom razvijaju zapaljive gasove
5.1	Oksidirajuće materije
5.2	Organski peroksidi
6.1	Otrovi
6.2	Gadne i zarazne materije
7	Radioaktivne materije
8	Korozivne (nagrizajuće) materije
9	Ostale opasne materije.

KUTIJA ZA PROTIVPOŽARNI APARAT



RAPIDEX broj:
OPRE0886

TEHNIČKE KARAKTERISTIKE:



Spoljašnje mere: 277 x 277 x 635 mm

Unutrašnje mere: 140 ÷ 185 mm

Kapacitet: 6 kg

Ostale karakteristike: vatrootporna, vodootporna i otporna na vibracije

PRIBORI A.D.R.

Slika	Opis	RAPIDEX broj
	Torba A.D.R. Sadrži: PVC rukavice, sredstvo za ispiranje očiju, zaštitne naočare, kompletnu masku, filter zaštitne maske i kecelju	OPRE00315
	Torba A.D.R. Sadrži: PVC rukavice, sredstvo za ispiranje očiju, zaštitne naočare, polumasku, filter zaštitne maske i kecelju	OPRE0070

PRIBORI A.D.R.

Slika	Opis	RAPIDEX broj
	Poklopac za kanalizacioni otvor 1000 x 1000 mm	OPRE0341
	Poklopac za kanalizacioni otvor 2000 x 3000 mm	OPRE0342
	Absorbujući granulat	OPRE0343
	Zaštitno odelo	OPRE0344
	Zaštitna šlem	OPRE0345
	Cipele	OPRE0346

PRIBORI A.D.R.		
Slika	Opis	RAPIDEX broj
	Reflektujući prsluk	OPRE0147
	Trougao upozorenja	OPRE0930
	Čunj	OPRE0347
	Čunj - reflektujući	OPRE0348
	Upozoravajuća lampa	OPRE0349
	Baterijska lampa	OPRE0350
	Preklapajuća lopata	OPRE0128

OPREMA		
Slika	Opis	RAPIDEX broj
	GUMENE ZAVESE 450 x 300 mm	OPRE0549
	GUMENE ZAVESE 650 x 400 mm	OPRE0548
	GUMENE ZAVESE 2400 x 400 mm	OPRE0541
	KLOCNA TOČKA metalna 160 mm	OPRE0359
	KLOCNA TOČKA metalna 200 mm	OPRE0183
	KLOCNA TOČKA plastična 160 mm	OPRE0225
	KLOCNA TOČKA plastična 200 mm	OPRE0912
	NOSAČ ZA KLOCNU 160 mm	OPRE0941
	NOSAČ ZA KLOCNU 200 mm	OPRE0947
	KUTIJA ZA ALAT 600 x 450 x 470 mm 700 x 450 x 650 mm 800 x 450 x 470 mm 1000 x 500 x 470 mm	OPRE0813 OPRE0950 OPRE0949 OPRE0948
	DIZALICA 8 t 12 t 16 t 20 t 30 t	OPRE0360 OPRE0361 OPRE0362 OPRE0208 OPRE0364
	RUDA ZA VUČU	OPRE0194
	PRIBOR ZA ČIŠĆENJE KABINE VOZAČA	OPRE0029

ZAŠTITA REZERVOARA OD KRAĐE GORIVA - KOCKON 105

RAPIDEX broj:	OPRE0814	RAPIDEX broj:	OPRE0803

ZAŠTITA REZERVOARA OD KRAĐE GORIVA - KOCKON 105 I ČEP

RAPIDEX broj:	OPRE0804	RAPIDEX broj:	OPRE0830

ČEP ZIPPER 105

RAPIDEX broj:	OPRE0808

ZAŠTITA REZERVOARA OD KRAĐE GORIVA - TERMOKING

RAPIDEX broj:	OPRE0819	RAPIDEX broj:	OPRE0820



PRIBOR ZA OSIGURAVANJE TERETA

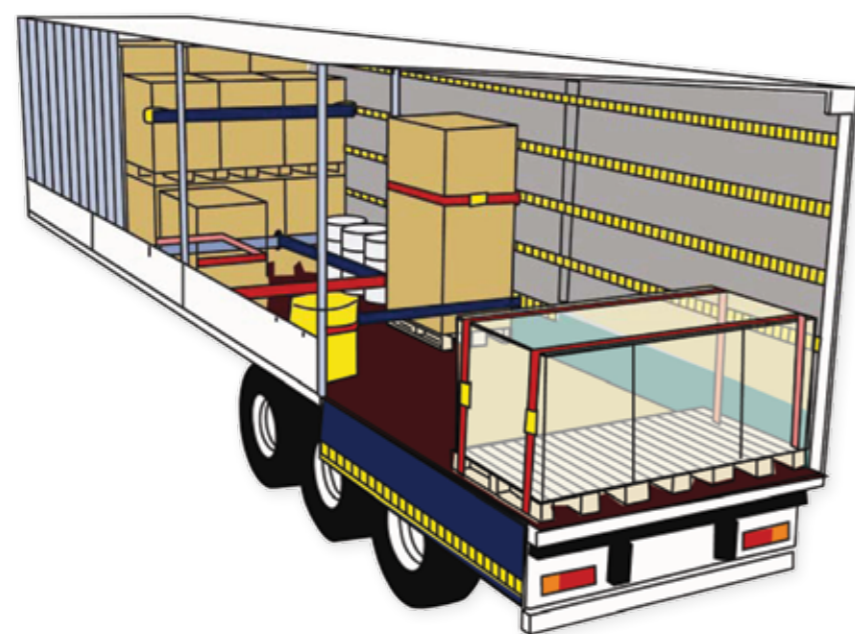
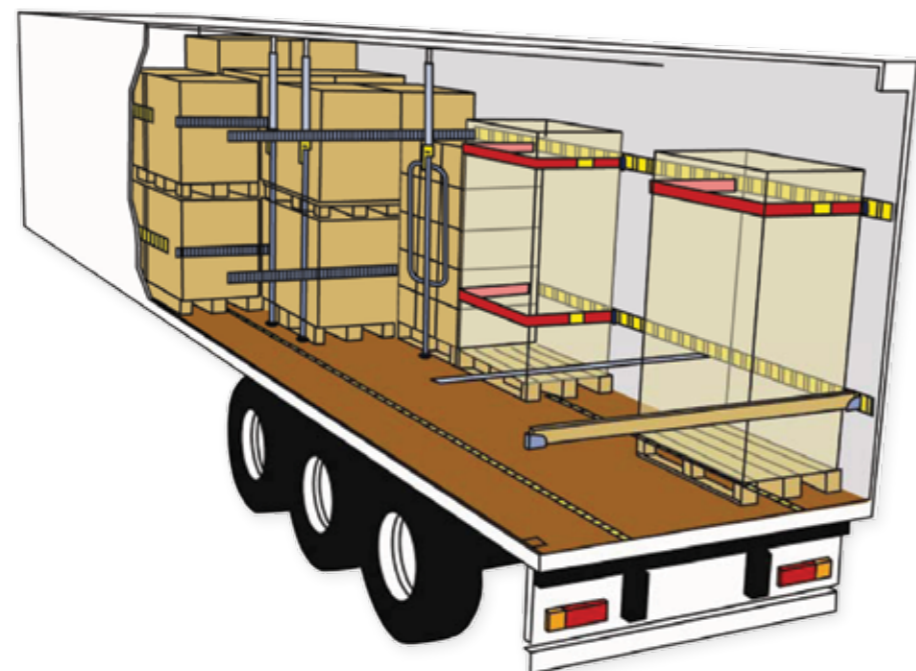

PRIBOR ZA OSIGURAVANJE TERETA



Poz.	Naziv	Dimenzije	Nosivost (daN)		RAPIDEX broj
1.	Traka za vezivanje tereta KPL	8 m x 50 mm	2500	5000	OPRE0185
2.	Traka za vezivanje tereta KPL	10 m x 50 mm	2500	5000	OPRE0184
3.	Traka za vezivanje tereta KPL	12 m x 50 mm	2500	5000	OPRE0170
4.	Traka za vezivanje tereta KPL Duga ručka	8 m x 50 mm	2500	5000	OPRE0780
5.	Traka za vezivanje tereta KPL Duga ručka	10 m x 50 mm	2500	5000	OPRE0779
6.	Traka za vezivanje tereta	10 m x 50 mm	2500	5000	OPRE001
7.	Štitnik robe	180 x 140 x 150 mm			OPRE0939



Poz.	Naziv	Dimenzije		RAPIDEX broj
1.	Letva ADR - aluminijum	21 - 36 mm	2400 - 2700 mm	OPRE0132



Poz.	Naziv	Dimenzije		RAPIDEX broj
1.	Držač - aluminijum	Ø42 mm	2100 - 2470 mm	OPRE0353
2.	Držač - aluminijum	Ø38 mm	2260 - 2630 mm	OPRE0133
3.	Držač - aluminijum	Ø42 mm	2350 - 2720 mm	OPRE0134
4.	Držač - aluminijum	Ø42 mm	2575 - 2965 mm	OPRE0700

8.4 LANCI ZA SNEG

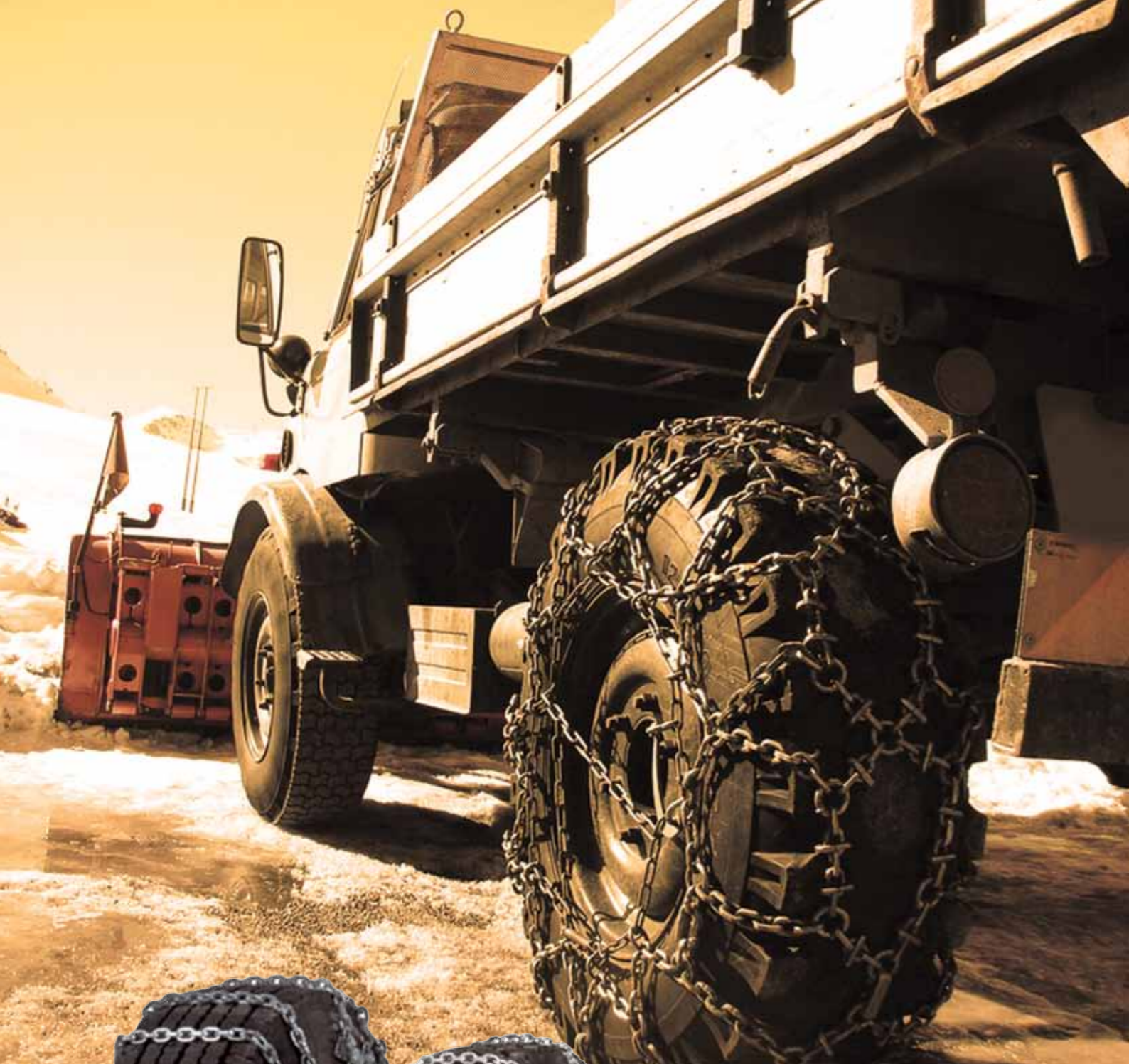

JEDNODELNI LANCI ZA SNEG

Poz.	Primena	RAPIDEX broj
1.	295/60 R22,5	OPRE0954
2.	315/60 R22,5	OPRE0953
3.	315/70 R22,5	OPRE0952
4.	315/80 R22,5	OSTA0198

TRODELNI LANCI ZA SNEG

Poz.	Primena				RAPIDEX broj
1.	205/75 R17,5 215/75 R17,5 225/75 R17,5 235/75 R17,5 7,00 R17,5 8,00 R17,5 8,50 R17,5 9,00 R17,5	7,00 R19,5 8,00 R19,5	6,50 R20		OPRE0357
2.	8,25 R17	245/70 R19,5 265/70 R19,5 275/70 R19,5 285/70 R19,5 9,00 R19,5 9,50 R19,5	7,50 R20 8,25 R20	225/70 R22,5 8,00 R22,5 9,00 R22,5	OPRE0112
3.	305/70 R19,5	9,00 R20	275/70 R22,5 295/70 R22,5 295/60 R22,5 305/60 R22,5 10,00 R22,5	9,50 R24	OPRE0358
4.	10,00 R20 11,00 R20 12,00 R20 12,5 R20 12/80 R20 13/80 R20	11,00 R22	11,00 R22,50 12,00 R22,5 13,00 R22,5 12/80 R22,5 275/80 R22,5 295/80 R22,5 315/80 R22,5 315/75 R22,5 305/70 R22,5 315/70 R22,5 315/60 R22,5	11.2 R24 305/75 R24,5 315/75 R24,5	OPRE0108

VUČNA KUKA AUTOMATSKA TIP 5055 A, DIN 74053, ISO 1102. D-50

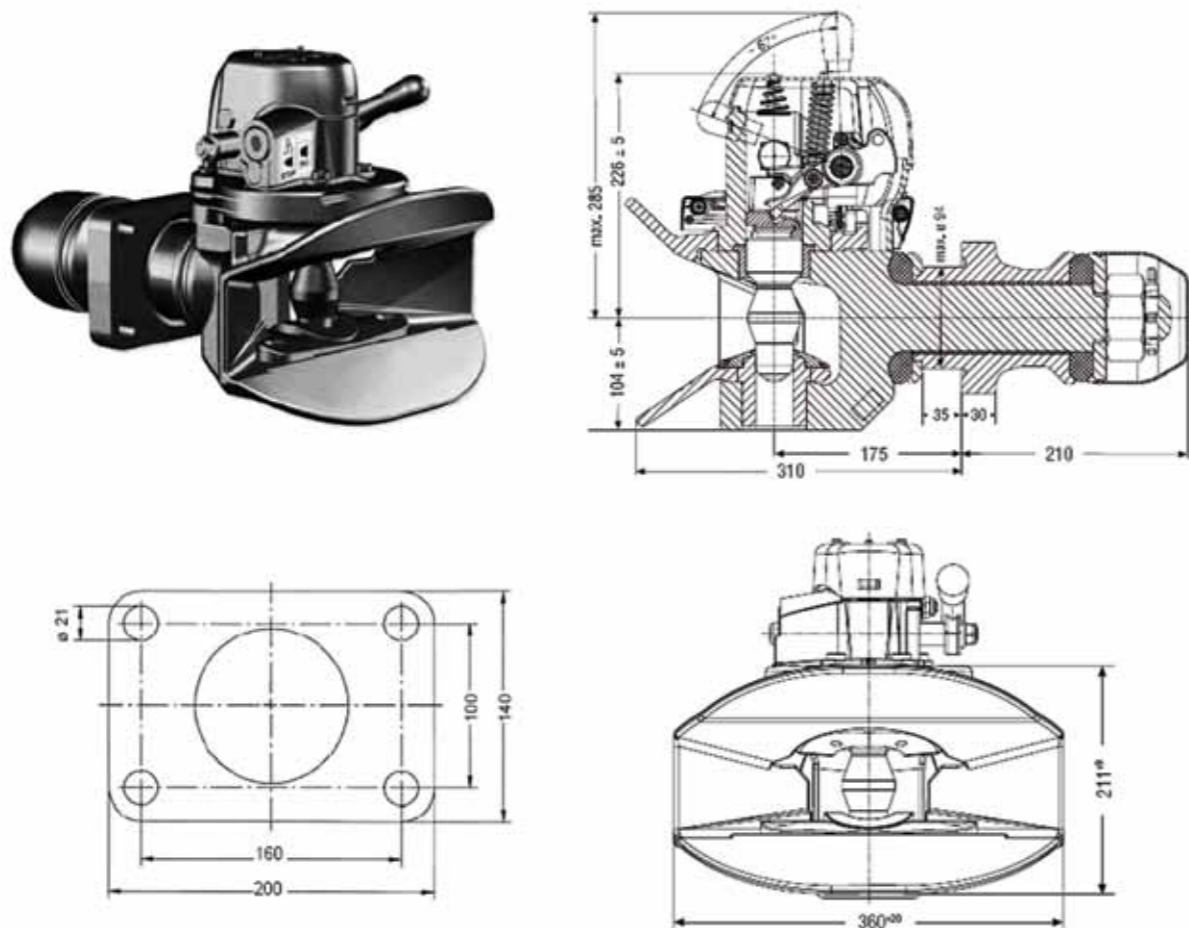

Tehničke karakteristike	Naziv	KBP	RAPIDEX broj
D = 200 kN DC = 135 kN V = 75/63 kN m = 50 kg	VUČNA KUKA	14 996 305	KARO0586
	GORNJA ČAURA	14 995 463	OPRE0237
	DONJA ČAURA	14 991 239	OPRE0236
	STOŽER	14 991 279	OPRE0238
	ZAŠTITNI LIM	14 991 255	OPRE0245

VUČNA KUKA AUTOMATSKA TIP 2045 G/145 G/150, DIN 74054, ISO 8755

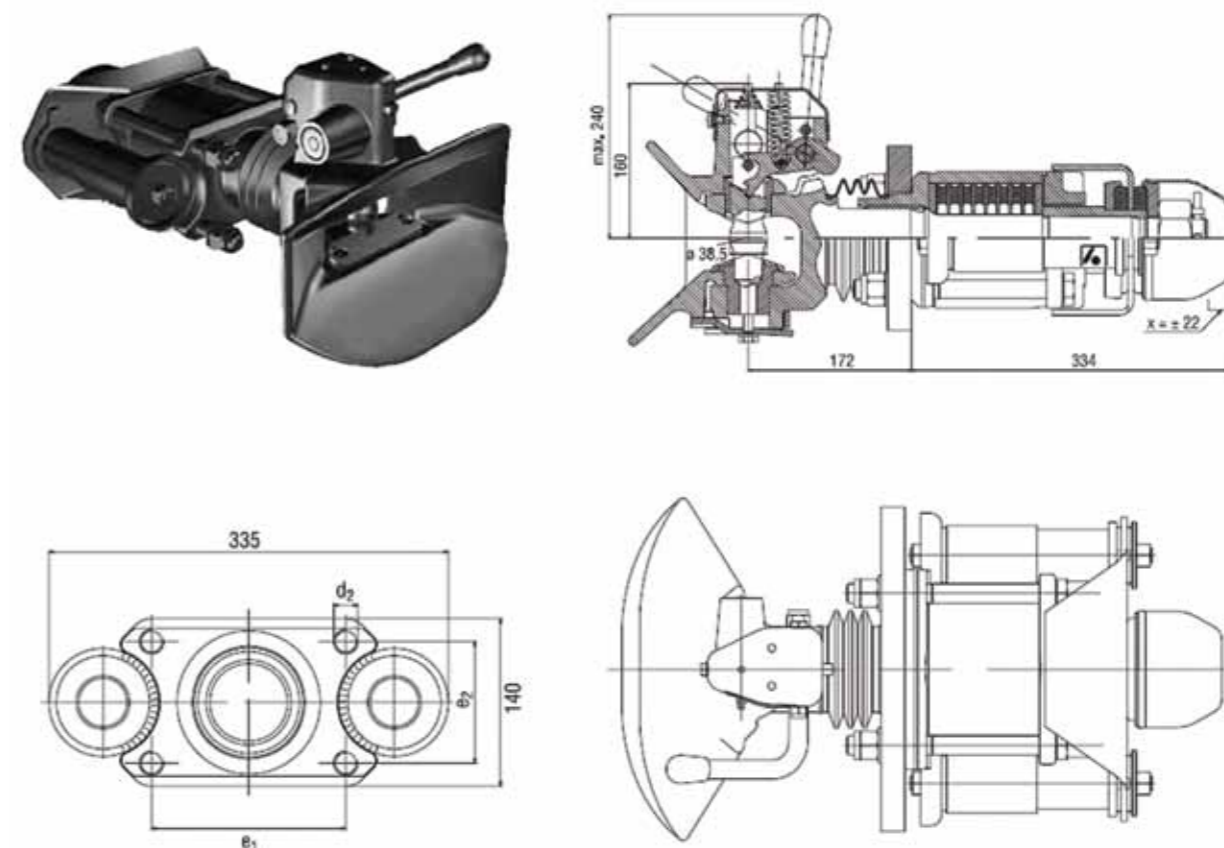

Tehničke karakteristike	Naziv	KBP	RAPIDEX broj
D = 100 kN G/145 D = 136 kN G/136 E1-G/145-140, G/150-160 E2-G/145-80, G/150-100	VUČNA KUKA	G/145 14 995 435	KARO0587
		G/150 14 995 447	KARO0651
	GORNJA ČAURA	6 997 899	OPRE0241
	DONJA ČAURA	6 997 880	OPRE0243
	STOŽER	12 991 452	OPRE0239

VUČNA KUKA AUTOMATSKA TIP 92/CX, DIN 74053, ISO 1102 D 50

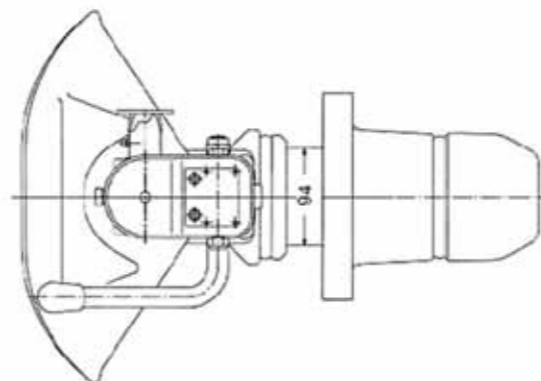
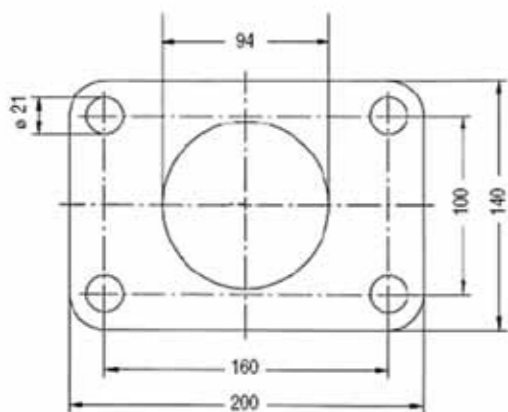
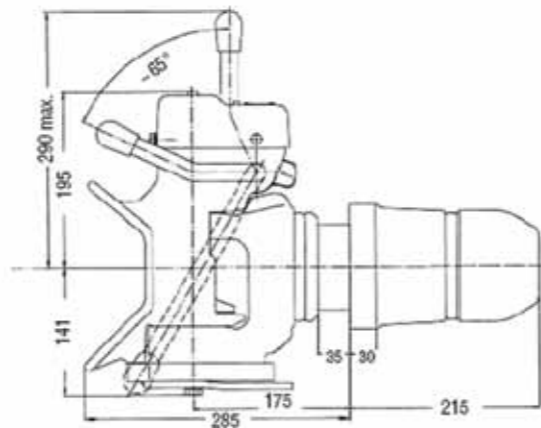

Tehničke karakteristike	Naziv	KBP	RAPIDEX broj
D = 190 kN DC = 130 kN V = 75 kN m = 50 kg	VUČNA KUKA	13 997 020	KARO0588
	GORNJA ČAURA	7 998 210	OPRE0242
	DONJA ČAURA	7 998 252	OPRE0244
	STOŽER	13 991 460	OPRE0240

AIR TOP 2000 ST



RAPIDEX broj:
HLAĐ0182

Napon (V)	Snaga (KW)	Potrošnja goriva (l/h)	Potrošnja energije (W)	Dimenzije (mm)	Težina uređaja (kg)
24	0,9 - 2,0	0,12 - 0,24	14 - 29	311 x 120 x 121	2,6

REZERVNI DELOVI - AIR TOP 2000 / 2000S / 2000ST

Poz.	Slika	Naziv / Opis	KBP	RAPIDEX broj
1.		GORIONIK AT 2000	65786A	HLAĐ0146
2.		MOTOR GREJČA AT 2000 / S	70678A	KABI0004
3.		SVEĆICA-GREJAČ AT 2000 / S	82307A	KABI0003
4.		SENZOR PLAMENA AT 2000	82306C	HLAĐ0178
5.		ZAPTIVKA AT 2000 / S / ST	1303517A	HLAĐ0751

REZERVNI DELOVI - AIR TOP 2000 / 2000S / 2000ST				
Poz.	Slika	Naziv / Opis	KBP	RAPIDEX broj
6.		PUMPA GORIVA AT 2000	65210A	ELEK0505
7.		ELEKTRONIKA AT 2000	87453B	KABI1458
8.		GORIONIK AT 2000 ST	1302799	HLAĐ0656
9.		MOTOR GREJAČA AT 2000 ST N.TIP	1302788	HLAĐ0752
10.		MOTOR GREJAČA AT 2000 ST S.TIP	1303848A	ELEK1716
11.		SVEĆICA-GREJAČ AT 2000 ST	9005087A	HLAĐ0753

AIR TOP 3500 ST					
					RAPIDEX broj: HLAĐ0861
Napon (V)	Snaga (KW)	Potrošnja goriva (l/h)	Potrošnja energije (W)	Dimenzije (mm)	Težina uređaja (kg)
24	1,5 - 3,5	0,18 - 0,42	15 - 33	428 x 148 x 162	5,9

REZERVNI DELOVI - AIR TOP 3500 ST				
Poz.	Slika	Naziv / Opis	KBP	RAPIDEX broj
1.		GORIONIK AT 3500 ST	9004220A	KABI1451
2.		MOTOR GREJAČA AT 3500 ST	9005916A	HLAĐ0754
3.		SVEĆICA-GREJAČ AT 3500 ST	9004215	HLAĐ0755

AIRTRONIC D2



RAPIDEX broj:
HLAD0185

Kapacitet grejanja	W	2200	1800	1200	850
Protok toplog vazduha	kg/h	105	90	60	40
Potrošnja energije	W	34	22	12	8
Potrošnja goriva	l/h	0,28	0,23	0,15	0,1
Dimenzije uređaja	mm	310 x 115 x 122			
Težina uređaja	kg	2,7			

REZERVNI DELOVI - AIRTRONIC D2

Poz.	Slika	Naziv / Opis	KBP	RAPIDEX broj
1.		GORIONIK	252069100100	KABI1459
2.		ZAPTIVKA GORIONIKA	252069060001	KABI1465
3.		MOTOR GREJAČA	252070992000	KABI1460
4.		ZAPTIVKA MOTORA GREJAČA	252069010003	KABI1456

REZERVNI DELOVI - AIRTRONIC D2

Poz.	Slika	Naziv / Opis	KBP	RAPIDEX broj
5.		GREJAČ-SVEČICA	252070010300	KABI1464
6.		SITO SVEČICE KPL	252069100102	KABI1452
7.		SITO SVEČICE	252069100102	KABI1467
8.		PUMPA GORIVA	224518010000	KABI1461

AIRTRONIC D4



RAPIDEX broj:
HLAD0186

Kapacitet grejanja	W	4000	3000	2000	900
Protok toplog vazduha	kg/h	185	140	100	55
Potrošnja energije	W	55	30	16	7
Potrošnja goriva	l/h	0,51	0,38	0,25	0,11
Dimenzije uređaja	mm	376 x 140 x 150			
Težina uređaja	kg	4,5			

REZERVNI DELOVI - AIRTRONIC D4				
Poz.	Slika	Naziv / Opis	KBP	RAPIDEX broj
1.		GORIONIK	252113100100	KAB1462
2.		MOTOR GREJAČA	252114992000	KAB1450
3.		ZAPTIVKA MOTORA GREJAČA	252113010003	KAB1463
4.		GREJAČ-SVEĆICA	252070010300	KAB1464
5.		SITO SVEĆICE KPL	252069100102	KAB1452
6.		SITO SVEĆICE	252069100102	KAB1467
7.		PUMPA GORIVA	224518010000	KAB1461

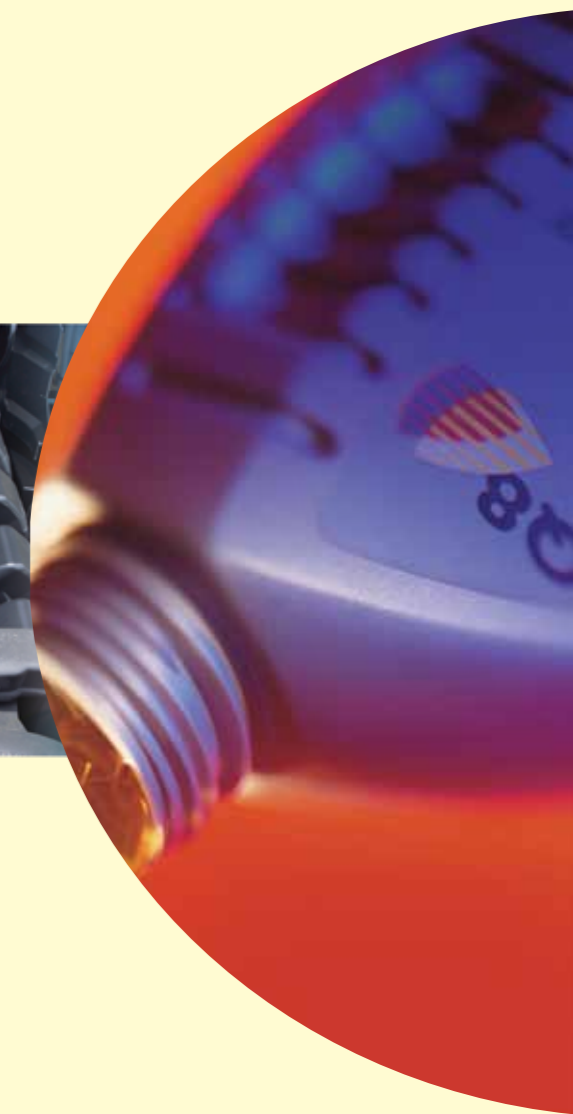

Uvod

Zaštita vašeg motora i ušteda goriva je uvek bila važna uloga Q8 motornih ulja. Zahvaljujući inovacijama, emisija od 25 kamiona danas je jednaka 1 kamionu od pre 30 godina. Da bi se produžio vek ovih motora i vek sistema za prečišćavanje izduvnih gasova, razvili smo novu liniju Q8 Oils maziva za teške dizel motore.

Trendovi

U skladu sa strogim propisima EU o emisiji gasova, svaki moderno dizajnirani kamion sadrži komponente kao što su katalizator, EGR i filtere protiv čađi. Kompanija Q8 Oils razvila je liniju maziva koja ovim komponentama dugoročno obezbeđuje da budu čisti. Time se ujedno smanjuju troškovi održavanja kao i veliki troškovi zamene zagađenih delova; na primer, naknadna ugradnja SCR sistema u proseku košta 7.000,00 EUR.

Naša tehnologija koja je ugrađena u proizvodima Q8 T 904, Q8 T 905, Q8 T 910 i Q8 T 760 obezbeđuje smanjenje vaših troškova održavanja.

Maziva koja obezbeđuju smanjenu potrošnju goriva postala su još privlačnija zato što u najnovijim EURO VI motorima za sve vrste kamiona odobreno je korišćenje ulja sa niskim nivoom gustine, što ujedno predstavlja i za vas priliku da sačuvate novac i garanciju. Maziva koja preporučujemo za smanjenu potrošnju goriva su sledeća: Q8 T 910 5W-30, Q8 T 904 FE 10W-30, Q8 T 760 10W-30 and Q8 SuperTruck FE 5W-30.



Motorna ulja za transportna vozila

Za dugi servisni interval potrebna su ulja visokog kvaliteta, kao što su Q8 T 904 FE ili Q8 T 910.

Rešenje koje pruža kompanija Q8 Oils

U niže navedenoj tabeli prikazani su proizvodi Q8 motorna ulja koja se preporučuju prema vrsti kamiona. SAPS kateorija (Sulphated Ash Phosphorous Sulphur) namenjena za sisteme pročišćavanja izduvnih gasova je specificirana od strane proizvođača kamiona. Izborom Q8 maziva, možete da preferirate između uštede ulja ili periode zamene ulja.

			Ekonomična potrošnja	Osobine pri paljenju hladnog motor	Period zamene ulja						
					DAF	MAN	Mercedes	Volvo	Renault	Iveco	Scania
NISKA VREDNOST PEPELA	Q8 T 904	10W-40	★★	★★	Long Drain	Long Drain	Long Drain	Medium Drain	Medium Drain	Long Drain (*)	-
	Q8 T 905	10W-40	★★	★★★	Long Drain	Long Drain	Long Drain	Medium Drain	Medium Drain	Long Drain (*)	Medium Drain (**)
	Q8 T 904 FE	10W-30	★★★	★★★	Long Drain	Long Drain	Long Drain	Medium Drain	Medium Drain	Long Drain (*)	-
	Q8 T 910	5W-30	★★★★	★★★★	Long Drain	Long Drain	Long Drain	Medium Drain	Medium Drain	Long Drain (*)	-
SREDNJA VREDNOST PEPELA	Q8 T 760	15W-40	*	★★	Medium Drain	Medium Drain	Medium Drain	Long Drain	Long Drain	-	Short Drain (***)
	Q8 T 760	10W-30	★★★	★★★	Medium Drain	Medium Drain	Medium Drain	Long Drain	Long Drain	-	Short Drain (***)
VISOKA VREDNOST PEPELA	Q8 T 860 S	10W-40	★★	★★★	Long Drain	Long Drain	Long Drain	Long Drain	Long Drain	Long Drain	Long Drain (***)
	Q8 Super Truck FE	5W-30	★★★★	★★★★	Long Drain	Long Drain	Long Drain	Long Drain	Long Drain	Long Drain	Long Drain

(*) od Iveco generacije EURO VI
 (**) EURO VI Scania motori
 (***) Scania motori sa DPF filterom

NISKA VREDNOST PEPELA	Q8 T 910	5W-30	FUEL saver	Dizajnirano za uštedu goriva, mazivo niskog viskoziteta sa odličnim osobinama pri paljenju hladnih motora za skoro sve vrste Euro IV, V i VI dizel motora. Ovo sintetičko ulje sa odličnim performansama i SAPS tehnologijom niske vrednosti razvijeno je specijalno za komercijalna vozila sa dizel filterom za čišćenje čestica (DPF).
	Specifikacije:	ACEA E6/E7; API CI-4		
	Odobrenja:	MAN 3477; MB 228.51; VOLVO VDS-3; RENAULT RLD-2; MACK EO-N		
Q8 Oils preporuke:		DEUTZ DQC IV-10 LA; MACK EO-M PLUS; MTU TYP-3.1; RENAULT VI RGD/RXD; VOLVO CNG		
NISKA VREDNOST PEPELA	Q8 T 905	10W-40		Sintetičko motorno ulje visokih performansi za teške uslove rada sa niskom vrednošću SAPS-a. Dizajniran je za podmazivanje velikog broja Euro IV, V i VI dizel motora opremljenih sa filterom za čišćenje čestica (DPF) ili katalizatorom (kao SCR) i radi na dizel gorivu sa malo sumpora i pod teškim uslovima. Takođe odgovara i Euro III motorima. Q8 T 905 ima odlična svojstva pri paljenju hladnih motora.
	Specifikacije:	ACEA E6/E7/E9; API CI-4;		
	Odobrenja:	DEUTZ DQC III-10 LA; MACK EO-N; MAN 3477; MB 228.51; MTU TYP-3; RENAULT VI RLD-2; SCANIA Low Ash; VOLVO VDS-3		
Q8 Oils preporuke:		CUMMINS CES 20076/77; DAF; MACK EO-M PLUS; MB 226.9; MTU TYP 3.1; RENAULT VI RGD, RXD; VOLVO CNG; MAN 3271-1; CATERPILLAR ECF-1a		
NISKA VREDNOST PEPELA	Q8 T 904 FE	10W-30	FUEL saver	Dizajniran za štednju goriva, mazivo niskog viskoziteta za skoro sve Euro IV, V i VI dizel motore. Sintetičko motorno ulje visokih performansi za teške uslove rada sa niskom vrednošću SAPS-a.
	Specifikacije:	ACEA E6,E7; API CI-4		
	Odobrenja:	MAN M3477; MB 228.51; VOLVO VDS-3; RENAULT VI RLD-2; MACK EO-N		
Q8 Oils preporuke:		DAF; CUMMINS CES 20076/77; DEUTZ DQC III-10 LA		
NISKA VREDNOST PEPELA	Q8 T 904	10W-40		Sintetičko motorno ulje visokih performansi za teške uslove rada sa niskom vrednošću SAPS-a dizajniran je za podmazivanje skoro svih Euro IV, V i VI dizel motora.
	Specifikacije:	ACEA E6 /E7; API CI-4		
	Odobrenja:	MAN M3477; MB 228.51; MTU Type 3.1; RENAULT VI RLD-2; VOLVO VDS-3; MACK EO-N; DEUTZ DQC III-10 LA		
Q8 Oils preporuke:		DAF; CUMMINS CES 20076/77		
SREDNJA VREDNOST PEPELA	Q8 T 760	15W-40 10W-30	FUEL saver	SHPD (Super High Performance Diesel) dizel motorno ulje sa niskom vrednošću sulfatnog pepela i ograničenom vrednošću fosfora i sumpora, namenjeno za motore koji su u skladu sa Euro V standardom i Američkim EPA 2007 zahtevima za izduvne gasove. Pogodno je za duge intervale zamene ulja i za vozila opremljena sa filterima za čišćenje čestica i katalizatorima (npr. SCR). Q8 T 760 SAE 15W-40 takođe može da se koristi i za Euro II i III dizel motore. Q8 T 760 SAE 10W-30 je ulje koje štedi gorivo, niskog viskoziteta i nije pogodan za starije motore.
	Specifikacije:	ACEA E9; API CJ-4/API SN; CATERPILLAR ECF-1a/ECF-2/ECF-3		
	Odobrenja:	MACK EO-O PREMIUM PLUS; MAN 3575; MB228.31; RENAULT VI RLD-3; VOLVO VDS-4		
Q8 Oils preporuke:		CUMMINS CES 20081; DDC 93K218; DEUTZ DQC III-10; MAN 3275; MTU TYPE 2.1		
VISOKA VREDNOST PEPELA	Q8 T 860 S	10W-40		Dizel motorno ulje sa izuzetno visokim performansama koje se sastoji od sintetičkih baznih ulja. Razvijeno je motore kompanije Scania koja dozvoljava zamenu ulja na 120.000 km. Na tržištu je dostupno od marta 2013.
	Specifikacije:	ACEA E4/E7; API CF		
	Odobrenja:	SCANIA LDF-3		
Q8 Oils preporuke:		VOLVO VDS-3; MB 228.5; MAN 3277; RENAULT RLD-2		
VISOKA VREDNOST PEPELA	Q8 SuperTruck FE	5W-30	FUEL saver	Dizajnirano za uštedu goriva, mazivo niskog viskoziteta sa odličnim osobinama pri paljenju hladnih motora za skoro sve vrste Euro III i neke vrste Euro IV i V i dizel motora. Ovo je UHPD (Ultra High Performance Diesel) sintetičko dizel motorno ulje sa izuzetno visokim performansama koje omogućava produženi interval zamene ulja.
	Specifikacije:	ACEA E4/E7		
	Odobrenja:	MAN 3277; MB 228.5;		
Q8 Oils preporuke:		IVECO; CUMMINS CES 20071/72/76/77; MACK EO-M PLUS; MB 235.28; MTU TYPE-3; SCANIA LDF; VOLVO VDS-3		

VISOKA VREDNOST PEPELA	Q8 T 860	10W-40	UHPD dizel motorno ulje sa izuzetno visokim performansama na sintetičkoj bazi namenjeno je za skoro sve Euro III i pojedine Euro IV i V dizel motore. ACEA E4 specifikacija garantuje visok nivo čišćenja čađi u motoru.
	Specifikacije:		ACEA E4/E7; API CI-4
	Odobrenja:		CUMMINS CES 20077/78; DEUTZ DQC III-05; MACK EO-M PLUS; MAN 3277; MB 228.5; MTU TYPE-3; SCANIA LDF-2; TEDOM 258-3; VOLVO VDS-3
	Q8 Oils preporuke:		DAF; JASO DH-1; RENAULT VI RXD/RLD-2; VOITH RETARDER KLASSE A
VISOKA VREDNOST PEPELA	Q8 T 800	10W-40	Polu-sintetičko dizel motorno ulje visokih performansi namenjeno je za Euro III i Euro IV motore sa niskom emisijom izduvnih gasova, koje omogućava i smanjenje potrošnje goriva. Takođe je pogodno za dizel motore putničkih automobila i manje motore sa direktnim ubrizgavanjem.
	Specifikacije:		ACEA E7/B4/A3; API CI-4/SL
	Odobrenja:		MACK EO-N; MAN 3275; RENAULT VI RLD-2; TEDOM 258-3; VOLVO VDS-3, DEUTZ DQC III -10; MTU TYP-2
	Q8 Oils preporuke:		CUMMINS CES 20071/72/76/77/78; MACK EO-M PLUS; MB 228.3; MB 229.1; GLOBAL DHD-1; CATERPILLAR ECF-1/ECF-2
VISOKA VREDNOST PEPELA	Q8 T 750	15W-40	Q8 T 750 može da se koristi za sve četvorotaktne dizel motore sa gorivom koje ima malu vrednost sumora (<0.05 %) i za motore kamoiona, kao i za motore poljoprivrednih i industrijskih radilica koje rade pod teškim uslovima. Takođe može da se koristi kod benzinskih i dizel motora putničkih automobila.
	Specifikacije:		ACEA E7/B4/A3; API CI-4/SL;
	Odobrenja:		DEUTZ III-10; MACK EO-N PLUS; MAN 3275; VOLVO VDS-3; MB 228.3; MTU TYPE-2; RENAULT VI RLD, RLD-2; ZF TE-ML 04C/07C; CUMMINS 20071/72/76/77
	Q8 Oils preporuke:		MB 229.1; GLOBAL DHD-1; CATERPILLAR ECF-1/ECF-2



Ulja za menjače i osovine kod komercijalnih vozila

Kod savremenih menjača i osovina, od suštinskog značaja su dobra zaštita od trenja i termička stabilnost, da bi se postigao što duži servisni interval. Ulja za menjače imaju i veliki uticaj na potrošnju goriva. Kao na primer Q8 T 60Ntech u menjaču i Q8 T 66 u zadnjoj osovini.

	GL-4	GL-5	mil-prf 2104e	Synth. Base Oil Components	Long Drain	Fuel Economy	Drive Line = Gear Box + Rear Axle	Intarder Suited	DAF	Iveco	MAN	Mercedes	Renault	Scania	Volvo
MENJAC	Q8 Gear Oil XG	✓	✓	-	*	*	✓	-	-	-	✓	-	-	✓	-
	Q8 T60Ntech	-	-	-	**	**	-	✓	✓	✓	✓	-	✓	-	-
	Q8 Supergear S	GL-3	-	-	***	**	**	-	-	-	-	-	-	-	✓
	Q8 T 36	✓	-	-	***	***	*	-	-	-	-	✓	-	-	-
ZADNJA OSOVINA	Q8 Axle Oil XG	✓	✓	✓	-	*	✓	-	✓	✓	-	-	-	✓	-
	Q8 Trans XGS	✓	✓	✓	***	***	**	✓	✓	✓	✓	✓	-	-	-
	Q8 T 65	-	✓	-	***	***	**	-	-	-	-	-	-	-	✓
	Q8 Unigear GL-5	-	✓	-	**	**	**	-	-	-	-	-	-	-	✓
	Q8 T 66	✓	✓	✓	***	***	***	-	✓	✓	✓	✓	-	✓	✓

MENJAC	Q8 Gear Oil XG	80W-90	Q8 Gear Oil XG je automotivno univerzalno menjačko ulje za sinhronizovane i nesinhronizovane manualne menjače, osovine i sve komponente koje prenose snagu (od motora do zadnje osovine) i koje zahtevaju API GL-4/GL-5 nivo performansi. Odobreno je od strane kompanije Scania za servisni interval do 180.000 km.
	Specifikacije: Odobrenja:		API GL-4; API GL-5 SCANIA STO 1:0; SAE J 2360 (PRI GL 0208); MAN 341 E2/Z2, 342 M2; ZF TE-ML 02B/05A/12E
MENJAC	Q8 T 60 Ntech	75W-80	Q8 T 60 Ntech je ulje na sintetičkoj bazi za manualne menjače sa visokim performansama koji zahtevaju specijalne osobine tečnosti na niskim i visokim temperaturama, što rezultuje da se lakše menjaju brzine.
	Odobrenja: Q8 Oils preporuke:		ZF TE ML 02L MAN 341 Z3/E3/Z4; VOLVO 97305; ZF TE-ML 01L
MENJAC	Q8 SuperGear S	75W-80	Q8 SuperGear S je sintetičko ulje sa najnovijom tehnologijom aditiva za manualne menjače. Može se koristiti kao višenamensko ulje za manualne menjače kod kamiona, autobusa i putničkih automobila.
	Specifikacije: Q8 Oils preporuke:		API GL-3; VOLVO 97305 JOHN DEERE JDM J11C; VOLVO 97307
MENJAC	Q8 SuperGear V	75W-80	Q8 SuperGear V je sintetičko ulje razvijeno za Volvo manualne menjače. Može se koristiti kao ulje za manualne menjače u kamionima i autobusima.
	Specifikacije: Odobrenja: Q8 Oils preporuke:		API GL-4 VOLVO 97307 MAN 341 ZE-VR (former MAN 341 SL); VOITH RETARDER OIL CLASS C; EATON S SERIES TRANSMISSIONS
MENJAC	Q8 T 36	75W-90	Q8 T 36 je potpuno sintetičko ulje za "switch gear" menjače sa najvišim performansama koji zahtevaju posebna svojstva tečnosti na visokim i niskim temperaturama i time poboljšavaju prenose. Proizvod je razvijen specijalno za komercijalna vozila marke Mercedes.
	Specifikacije: Odobrenja:		API GL-4 MAN 342 TYP MB; MB 235.11
ZADNJA OSOVINA	Q8 Axle Oil XG	80W-140	Automotivno ulje koje je namenjeno za osovine i diferencijale. Odobreno je od strane kompanije Scania za servisni interval do 180.000 km.
	Specifikacije: Odobrenja: Q8 Oils preporuke:		API GL-4/GL-5; MIL-PRF-2105 E SCANIA STO 1:0; ZF TE-ML 05A/12E/16D/21A ZF TE-ML 02B
ZADNJA OSOVINA	Q8 Trans XGS	75W-90	Sintetičko automotivno ulje za zadnje osovine, diferencijale i pojedine manualne menjače koji rade pod teškim uslovima i koji zahtevaju posebne osobine tečnosti pri niskim temperaturama da bi se dobila niža potrošnja goriva i lakša promena brzina.
	Specifikacije: Odobrenja: Q8 Oils preporuke:		API GL-4/GL-5; MIL-PRF-2105-E MAN 341 E3/Z2, 342 M3; SCANIA STO 1:0; ZF TE-ML 02B/5A/12B MAN 342 S1
ZADNJA OSOVINA	Q8 T 65	75W-90	Sintetičko ulje za menjače koje pruža kombinaciju dobrih osobina tečnosti na niskim i visokim temperaturama. Time se smanjuje trenje i samim tim smanjuje se i buka prenosa i potrošnja goriva.
	Specifikacije: Odobrenja: Q8 Oils preporuke:		API GL-5 VOLVO 97312; ZF TE-ML 17B/19B ZF TE-ML 05A
ZADNJA OSOVINA	Q8 Unigear GL-5	75W-90	Automotivno ulje na sintetičkoj bazi namenjeno je za manualne menjačime i osovine u putničkim i komercijalnim vozilima.
	Specifikacije: Q8 Oils preporuke:		API GL-5; MIL-L-2105D ZF TE-ML 05A
ZADNJA OSOVINA	Q8 T 66	75W-110	Razvijen u cilju postizanja značajne uštede goriva za osovine u kamionima koji rade pod velikim opterećenjem. Relativno novi viskozitet SAE 110 se koristi radi postizanja optimalnog podmazivanja. Ovo sintetičko ulje je za podmazivanje visoko opterećenih komponenta, kao što su zadnje osovine, diferencijali i pojedini menjači. Potvrđeno je da Q8 T 66 smanjuje potrošnju goriva do 4,7 %.
	Specifikacije: Q8 Oils preporuke:		API GL-4/GL-5; API MT-1; MIL-PRF-2105E; SAE J 2360 ZF TE-ML-05B/12B; MACK GO-J; MB 235.8; MAN 341 S1; SCANIA STO 1:0

Ulja za automatske menjače u komercijalnim vozilima



Q8 Auto 14

Ulje za automatske menjače koje takođe odgovara za servo volane i kao hidraulično ulje.

Q8 Oils preporuke:

MB 236.7; VME; ZF TE-ML 14A; VOITH 55.6335.3X

Q8 Auto 15 ED

Q8 Auto 15 ED je ulje na sintetičkoj bazi za automatske menjače koje takođe odgovara za servo volane i kao hidraulično ulje.

Q8 Oils preporuke:

VOITH DIWA H55.6336.3X; ZF TE-ML 14B

Hidraulična ulja za komercijalna vozila



Q8 Haydn

10, 15,
22, 32,
46, 68,
100, 150

Univerzalno hidraulično ulje za višenamensku upotrebu sa indeksom viskoziteta vrednosti 100. Bazno ulje ima dobar prirodni otpor starenju (oskidaciji) i ujedno veoma svetlu boju. Ovo se lako filtrira.

Važeći za sledeće primene:

AFNOR 48-603, CATEGORY HM; MAG IAS P-68/P-69/P-70; DENISON HF-0/HF-1/HF-2; DIN 51524 PART 2, CATEGORY HLP; ISO 11158, CATEGORY HM; SS 155434, CATEGORY AM

Q8 Heller

15, 22,
32, 46,
68, 100

Q8 Heller je mineralno hidraulično ulje tipa HVLP sa izuzetno visokim indeksom viskoziteta, vrednosti 150. Q8 Heller je idealno za upotrebu u hidrauličnim sistemima koje rade u uslovima velikih temperaturnih promena. Optimalni viskozitet pri pokretanju u hladnim uslovima obezbeđuje neometani rad hidrauličnih sistema. Koristi se za kopačice i ostale mašine koje rade u spoljnim uslovima. Q8 Heller odgovara zahtevima većine proizvođača džipova.

Važeći za sledeće primene:

AFNOR 48-603, CATEGORY HV; DIN 51524 PART 3, CATEGORY HVLP; ISO 11158, CATEGORY HV

Masti za komercijalna vozila



Q8 Rembrandt EP 2

NLGI 2

Višenamenska litijumska mast unapređena sa aditivima koji poboljšavaju osobine otpornosti pri visokom pritisku i oksidaciji; takođe sadrži i inhibitor rđanja.

Veličina pakovanja:

50kg KEG, 12.5kg, 180kg, 12 x 400g (CART)

Q8 Rembrandt Moly

NLGI 2

Visoko kvalitetna višenamenska litijumska mast koja sadrži molibdenski disulfid koji obezbeđuje dodatnu zaštitu od trenja. Sadrži inhibitor rđanja i additive protiv oksidiranja.

Veličina pakovanja:

50kg KEG, 12.5kg, 180kg, 12 x 400g (CART)

Q8 Rembrandt EP 00 WV

NLGI 00

Litijumska mast za centralne sisteme podmazivanja marke Willy Vogel preporučuje se za upotrebu kada se zahtevaju specifikacije MB 264 i MAN 283. Specijalno za automotivne aplikacije gde je potrebno lako pumapanje pri niskim temperaturama.

Veličina pakovanja:

12.5kg, 50kg KEG, 12.5kg

Q8 Rubens WB Blau

NLGI 2

Višenamenska litijumska kompleksna mast za ležajeve u kamionima i prikolicama gde je potrebno lako pumapanje u centralnim sistemima za podmazivanje a zahteva se NLGI 2 mast.

Veličina pakovanja:

50kg KEG, 12.5kg, 12 x 400g (CART)

Ostali proizvodi



Q8 Brake Fluid DOT 4

Nepetrolejska kočiona tečnost sa osobinom stvaranja niskog parnog pritiska. Pogodna je za korišćenje u hidrauličnim sistemima kočnica i kvačila u svim putničkim automobilima, kamionima, autobusima i prikolicama gde se traže proizvodi visokih performansi. Ovaj proizvod se posebno preporučuje za funkcionisanje pri visokim temperaturama koje se stvaraju od kočionih diskova ili kada postoji dodatno opterećenje na kočionom sistemu.

Q8 Oils preporuke:

FMVSS 116 DOT 3; FMVSS 116 DOT 4; SAE J1703

Veličina pakovanja:

50kg KEG, 12.5kg, 180kg, 12 x 400g (CART)

Q8 Antifreeze Long Life

Univerzalni koncentrat antifrizna visokih performansi koji daje zaštitu tokom cele godine kao rashladna tečnost leti i antifriz zimi. Baziran je na etilen glikolu, hemijski stabilan i ne podleže koroziji.

Q8 Oils preporuke:

BS 6580, 5177; SAE J 1034; ASTM D 3306; FVV Heft R 443; MAN 324 TYPE SNF

Veličina pakovanja:

1L, 5L, 25L, 205L

Q8 Degreasing Fluid HFB

Višenamenski odmašivač koji se ispira vodom.

Veličina pakovanja:

25L, 208L

Q8 Oils

MOTORNO ULJE	Q8 T 905	208 litara	RAPIDEX BROJ - ULJA0171
	Q8 T 905	60 litara	RAPIDEX BROJ - ULJA0129
	Q8 T 905	20 litara	RAPIDEX BROJ - ULJA0130

MOTORNO ULJE	Q8 T 860	208 litara	RAPIDEX BROJ - ULJA0135
	Q8 T 860	60 litara	RAPIDEX BROJ - ULJA0128
	Q8 T 860	20 litara	RAPIDEX BROJ - ULJA0127
	Q8 T 860	5 litara	RAPIDEX BROJ - ULJA0157

MOTORNO ULJE	Q8 T 800	1000 litara	RAPIDEX BROJ - ULJA0185
	Q8 T 800	208 litara	RAPIDEX BROJ - ULJA0158
	Q8 T 800	60 litara	RAPIDEX BROJ - ULJA0193
	Q8 T 800	20 litara	RAPIDEX BROJ - ULJA0159
	Q8 T 800	5 litara	RAPIDEX BROJ - ULJA0160

MOTORNO ULJE	Q8 T 760	208 litara	RAPIDEX BROJ - ULJA0171
	Q8 T 760	20 litara	RAPIDEX BROJ - ULJA0129
	-	-	-

MOTORNO ULJE	Q8 T 750	208 litara	RAPIDEX BROJ - ULJA0136
	Q8 T 750	60 litara	RAPIDEX BROJ - ULJA0146
	Q8 T 750	20 litara	RAPIDEX BROJ - ULJA0145
	Q8 T 750	5 litara	RAPIDEX BROJ - ULJA0194

MOTORNO ULJE	Q8 T 520	208 litara	RAPIDEX BROJ - ULJA0161
	Q8 T 520	20 litara	RAPIDEX BROJ - ULJA0162
	-	-	-

ANTIFRIZ	G12 + KONCENTRAT	208 litara	RAPIDEX BROJ - HLA00648
	G12 + KONCENTRAT	20 litara	RAPIDEX BROJ - HLA00647
	-	-	-

MAST	Q8 REMBRANT EP2	192 kilograma	RAPIDEX BROJ - ULJA0246
	Q8 REMBRANT EP2	18 kilograma	RAPIDEX BROJ - ULJA0203
	Q8 REMBRANT EP2	5 kilograma	RAPIDEX BROJ - ULJA0183
	Q8 REMBRANT EP2	0,4 kilograma	RAPIDEX BROJ - ULJA0167
	Q8 RUBENS 00	18 kilograma	RAPIDEX BROJ - ULJA0184
	Q8 RUBENS WB/b	0,4 kilograma	RAPIDEX BROJ - ULJA0166

ULJE ZA KOČNICE I AUTOMATSKJE MENJAČE	Q8 BRAKE FLUID DOT4	0,25 litara	RAPIDEX BROJ - ULJA0163
	Q8 AUTO 15 ATF	20 litara	RAPIDEX BROJ - ULJA0182
	Q8 AUTO 15 ATF	1 litra	RAPIDEX BROJ - ULJA0165
	Q8 LHM MINERALNO ULJE	1 litra	RAPIDEX BROJ - ULJA0164
	-	-	-

HIDROL	Q8 HAYDN 10	208 litara	RAPIDEX BROJ - ULJA0240
	Q8 HAYDN 32	208 litara	RAPIDEX BROJ - ULJA0218
	Q8 HAYDN 46	208 litara	RAPIDEX BROJ - ULJA0212
	Q8 HAYDN 46	20 litara	RAPIDEX BROJ - ULJA0215
	Q8 HAYDN 68	208 litara	RAPIDEX BROJ - ULJA0213
	Q8 HAYDN 68	20 litara	RAPIDEX BROJ - ULJA0216
	Q8 HELLER 46	208 litara	RAPIDEX BROJ - ULJA0214
	Q8 HELLER 68	208 litara	RAPIDEX BROJ - ULJA0191
	-	-	-

ULJE ZA MENJAČ I DIFERENCJAL	Q8 T 60	75W-80	60 litara	RAPIDEX BROJ - ULJA0238
	Q8 T 60	75W-80	20 litara	RAPIDEX BROJ - ULJA0241
	Q8 T 36	75W-90	208 litara	RAPIDEX BROJ - ULJA0237
	Q8 T 65	75W-90	60 litara	RAPIDEX BROJ - ULJA0180
	Q8 T 65	75W-90	20 litara	RAPIDEX BROJ - ULJA0178
	Q8 T 35	80W	20 litara	RAPIDEX BROJ - ULJA0143
	Q8 T 55	80W-90	208 litara	RAPIDEX BROJ - ULJA0200
	Q8 T 55	80W-90	60 litara	RAPIDEX BROJ - ULJA0199
	Q8 T 55	80W-90	20 litara	RAPIDEX BROJ - ULJA0139
	Q8 T 55	80W-90	1 litra	RAPIDEX BROJ - ULJA0188
	Q8 T 55	85W-140	20 litara	RAPIDEX BROJ - ULJA0181
	-	-	-	-



NOVI SAD

Novosadski put 160
21000 Novi Sad
Srbija

Tel./Fax.

021 651 0521
021 651 0522
021 651 0523
021 651 1228
021 651 2254
060 824 8801

e-mail: office@rapidex.co.rs

BEOGRAD

Milošev kladenac BB

Tel./Fax.

011 406 59 48
011 406 67 82
011 406 67 83
060 824 8804

PARAĆIN

Carice Milice 54

Tel./Fax.

035 8 567 611
035 8 567 671
060 824 8833

ČAČAK

Konjevići bb

Tel.

032 559 0037
060 824 8821

LOZNICA

Bulevar Dositeja Obradovića 70

Tel.

015 877 883
015 877 884
060 824 8810

NOVI PAZAR

Save Kovačevića 300

Tel.

020 315 156,
060 824 8824

VRANJE

Ivana Meštrovića 27

Tel.

017 410 088
060 824 8835

office@rapidex.co.rs

www.rapidex.co.rs

SOMBOR

XII Vojvođanske udarne
brigade 130

Tel.

025 461 481
060 824 8850

SUBOTICA

Beogradski put 21

Tel.

024 556 246
060 824 8862

VRBAS

Ivana Milutinovića 11

Tel.

021 700 087
060 824 8806

NIŠ

Bulevar 12. Februar 152

Tel./Fax.

018 585 824
060 824 8874



LAKTAŠI

RAPIDO DOO

Cara Dušana 218

Tel.

+ 387 51 584 544

BIJELJINA

RAPIDEX DOO

Pantelinska 1

Tel./Fax.

+387 55 247 687



